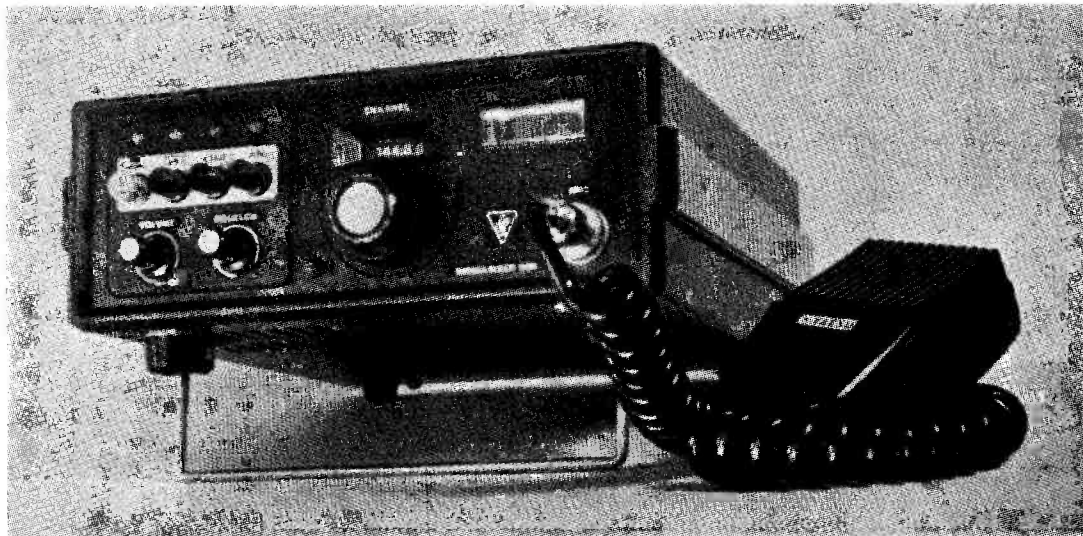
**FT501**

Digital readout, 560W p.e.p., separate 9 MHz filters for USB and LSB, separate 9 MHz CW filter.

The very latest and best at a price only a fraction above the norm.

**£300 plus V.A.T.**

**Sigmasizer**

Complete coverage of 2m in 10 kHz steps.

This F.M. rig is fantastic value at only **£165.00 plus V.A.T.**

**LOWE ELECTRONICS**

**119 CAVENDISH ROAD, MATLOCK, DERBYSHIRE,  
DE4 3HE.**

**Tel. Matlock 2817/2430**

MEMBERS OF THE AMATEUR RADIO RETAILERS ASSOCIATION



# NEW HEATHKIT 2-METRE F.M. SOLID-STATE AMPLIFIER

**An economy approach to boost mobile power—small in size and price but just look at this spec!**

**40 watts nominal out for 10 watts in—requires only 12 VDC supply.**

**Perfect match for the HW-202 Transceiver—also gives fully automatic operation with any 2-metre exciter delivering 5-15 watts drive.**

**Solid-state design—**all components mount on single board for fast, easy assembly.

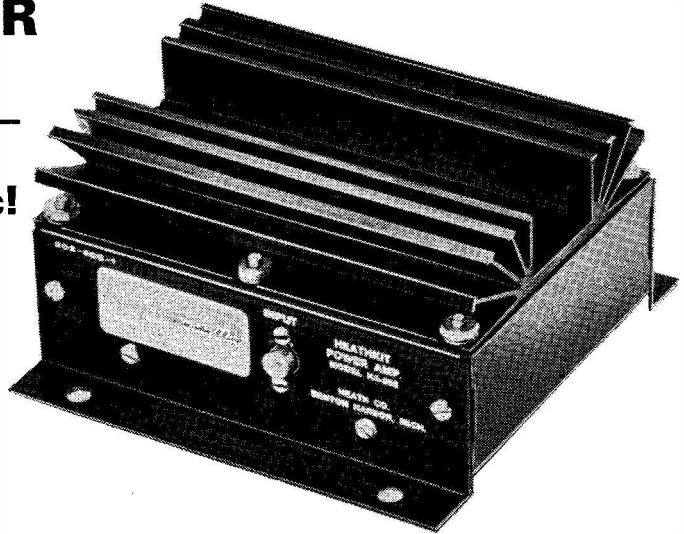

**If you're regularly working from a fringe area,** the new Heathkit HA-202 2-metre Amplifier can boost your mobile output to 40 watts (nominal), while pulling a maximum of 7 amps from your car's 12 volt battery.

You can mount the compact HA-202 wherever it's convenient—in the boot or under the dashboard. Use it with HW-202 2-metre Transceiver, or with any 2-metre exciter delivering 5-15 watts drive.

**Fully automatic operation—**an internal antenna changeover relay and sensing circuitry provide automatic transmit/receive switching. The all solid-state design features rugged, emitter-ballasted transistors, combined with a highly efficient heat sink. This permits the HA-202 to withstand high VSWR loads, yet remain cool and continue to transmit without the need for complex sensing circuits.

Tuned input/output circuits provide a low spurious content, yet allow coverage of any 1.5 MHz segment of the 2-metre band without re-adjustment.

**Easy, 4-hour assembly—**all components mount on one printed circuit board. Then you align your HA-202 with either a VOM or VVM. The manual shows you how, every step of the way. Installation is even faster!

Kit includes transceiver connecting cable as well as antenna connector. The HA-202 is designed for operation from a 12 VDC system. Additional power supplies are not required.

**HA-202 SPECIFICATION—Frequency Range:** 143-149 MHz. **Power Output :** 20W at 5W in, 30W at 7.5W in, 40W at 10W in, 50W at 15W in. **Power Input (rf drive):** 5-15W. **Input/Output Impedance:** 50 ohms, nominal. **Input VSWR:** 1.5:1 max. **Power Supply Requirements:** 12 to 16 VDC, 7 amps max. **Operating Temperature Range:** -30 F to +140 F. **Dimensions:** 3" h x 5½" d x 4¼" w. (Excluding mounting flanges).

## KIT K/HA-202

(Mail order prices and specifications subject to change without notice)

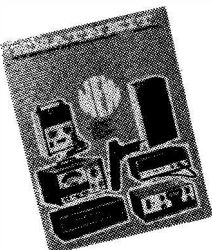

### FREE CATALOGUE

Post the coupon NOW for a FREE copy of the world-famous HEATHKIT Hi-Fi Audio/Instrumentation Catalogue.

**Please send me a FREE Heathkit catalogue**

Name \_\_\_\_\_

Address \_\_\_\_\_

\_\_\_\_\_

\_\_\_\_\_

\_\_\_\_\_

**HEATH** Heath (Gloucester) Limited, Dept. SW/03/73  
**Schlumberger** Gloucester GL2 6EE. Telephone 0452 29451



# ANNOUNCE

# A NEW SERVICE

JUST PHONE YOUR ORDER IN!

NO LETTER WRITING — NO MONEY REQUIRED — JUST QUOTE YOUR ACCESS CARD NUMBER AND  
WE DESPATCH THE GOODS!

This service will be available to callers, mail and telephone customers ; just another part of the finest service available to the U.K. Amateurs. We hope you'll give it a try ! We'll despatch your order the same day if humanly possible by whatever means you wish.

You may order anything which we sell by this high speed service, including used equipment, up to the limit of your Access card.

**NOW IS YOUR LAST CHANCE!**

Don't forget all prices go up by 10% V.A.T. in April on everything which we sell except Caslon Clocks. You'd be wise to make that possible change in your station now !

H.P. With inflation and V.A.T. you may as well get the goods on H.P.!

EXAMPLES OF HIRE PURCHASE  
Monthly Repayments over :

Model	Deposit	1 Year		H.P. Price	1½ Years		H.P. Price	2 Years		H.P. Price	3 Years		H.P. Price
FR50B ...	£7-00	5-£6 ; 7-£5	£74-00	16-£4 ; 2-£3	£77-00	2-£4 ; 22-£3	£81-00	11-£3 ; 25-£2	£90-00				
FR400SDX ...	£16-00	6-£14 ; 6-£13	£178-00	9-£10 ; 9-£9	£187-00	12-£8 ; 12-£7	£196-00	18-£6 ; 18-£5	£214-00				
FT1FT75 ...	£12-50	3-£11 ; 9-£10	£135-50	3-£8 ; 15-£7	£141-50	16-£6 ; 8-£5	£148-50	6-£5 ; 30-£4	£162-50				
FT1FF200 ...	£18-00	5-£15 ; 7-£14	£191-00	2-£11 ; 15-£10	£201-00	1-£9 ; 23-£8	£211-00	32-£6 ; 4-£5	£230-00				
FT-101 ...	£26-00	6-£22 ; 6-£21	£284-00	2-£16 ; 16-£15	£298-00	22-£12 ; 2-£11	£312-00	27-£9 ; 9-£8	£341-00				
FT401 ...	£23-00	5-£20 ; 7-£19	£256-00	12-£14 ; 6-£13	£269-00	19-£11 ; 5-£10	£282-00	33-£8 ; 3-£7	£308-00				
FT-2FB ...	£9-00	7-£8 ; 5-£7	£100-00	6-£6 ; 12-£5	£105-00	6-£5 ; 18-£4	£111-00	4-£4 ; 32-£3	£121-00				
FT-2 AUTO ...	£15-00	3-£13 ; 9-£12	£162-00	12-£9 ; 6-£8	£171-00	20-£7 ; 4-£6	£179-00	36-£5 ; 1-£2	£195-00				
YC-305 ...	£9-00	2-£8 ; 10-£7	£95-00	1-£6 ; 17-£5	£100-00	1-£5 ; 23-£4	£106-00	35-£3 ; 1-£2	£116-00				
YC-305D ...	£12-00	4-£10 ; 8-£9	£124-00	11-£7 ; 7-£6	£131-00	6-£6 ; 18-£5	£138-00	31-£4 ; 5-£3	£151-00				
FL-2100 ...	£15-00	6-£13 ; 6-£12	£165-00	14-£9 ; 4-£8	£173-00	22-£7 ; 2-£6	£181-00	3-£6 ; 33-£5	£198-00				

REMEMBER! THE YAESU RANGE IS SECOND TO NONE & LIKE OUR SERVICE !

**SPARES:** We carry a full stock of factory recommended spares and more besides!

**SERVICE:** We do all labour FREE on warranty claims.

**GUARANTEE:** We maintain the YAESU 12 months guarantee.

**DELIVERY:** We deliver within 24 hrs. of receipt of order of items which are in stock. This is the **fastest delivery service in the country** and costs £1 per parcel only ! 48 hr. service to Scotland and remote places.

**COLLECTION:** In the unlikely event of your having faulty equipment, all you have to do is phone/write us and we will collect by SECURICOR AT OUR EXPENSE and return the unit to you AT OUR EXPENSE.

## EVERY MODEL BELOW, EX-STOCK

As there will be a last minute rush to beat V.A.T. you'll be wise to place your order with us now. Dial 04216 4930 and Mary or Hilary will soon confirm availability.

YAESU PRICES—CARRIAGE PAID BY SECURICOR

### HF TRANSCEIVERS

FT-75. 50W p.e.p. 10-80m. 3 Ch. vxo ... £99-00

FP-75. AC PSU and Speaker for above ... £22-50

DC-75 DC PSU SPEAKER and MOBILE MOUNT £22-50

FT-200 240W. p.e.p. 10-80m. ... £134-00

FP-200 AC PSU and SPEAKER for FT-200 ... £38-00

DC-200 DC PSU for FT-200 ... £46-50

FT-101. 10-80m. AC & DC PSU built-in NEW

MODEL ... £249-00

FT-101 as above + 160m. NEW MODEL ... £255-00

FT-401. 560W. p.e.p. 10-80m. ... £230-00

### VHF TRANSCEIVERS

FT-2FB 2m. 12 Channel, 10W. O/P FM. NEW ! £89-00

FP-2AC AC PSU and SPEAKER ... £25-50

FP-2 ACB. AC PSU/Sprk. and Ni.cad batteries £36-00

FT-2 AUTO -2m. 8 Ch. Scanning ... £146-00

### HF TRANSMITTERS

FL 50. 50W. p.e.p. 10-80m. VXO control ... £68-00

FL 50 fitted VOX ... £72-00

FL400. 240W. 10-80m. Transceivers with matching FR400 receiver ... £146-00

### HF RECEIVERS

FR50. Double conversion 10-80m. ... £59-00

FR50 fitted WWV and xtal. Calibrator... £63-00

FR400DX. 160m. 80-10m. (28-29 MHz) ... £120-00

FR400SDX. 160-2m. 4 Mech. Filters, 28-30 MHz £160-00

### REMOTE VFO's

FV-101 for FT-101, FV-200 for FT-200 ... £38-00

FV-401 for FT-401 ... £38-00

FV-50 for FT-75 and FL50... £27-50

### FREQUENCY COUNTERS

YC-305. 35 MHz AC and 12v. DC ... £85-00

YC-355. 35 MHz AC only ... £85-00

YC-305D. 220 MHz. Built-in pre-scaler ... £111-00

YC-355D. 220 MHz AC and 12v. DC ... £111-00

### LINEAR AMPLIFIERS

FL-2100W p.e.p. 10-80m. (Matches FT-101) ... £148-00

FL-2000B. As above Matches FL400 ... £148-00

FL-2500 2kW p.e.p. 160-10m. ... £122-00

## FT-101 SPECIAL FREE OFFER!

For a limited period only we offer any licensed amateur whose QTH appears in the Callbook the opportunity to try in your own home on your own antenna the FT-101 (old model). Compare it against your present gear and marvel at its superb performance (sensitivity on 28 MHz etc.) and if you're not satisfied merely send it back to us. DO NOT SEND ANY MONEY ! You have the FT-101 for seven days and then either send us the "101" back or £229-00 ! We will pay the carriage both ways so that you are put to no expense whatsoever !



# OUR AESU MUSEN MAIN DISTRIBUTOR

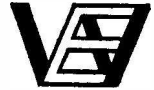

**NEW ! FT-501, 500w. p.e.p. 10-80m. SSB TRANSCEIVER**  
**INTRODUCTORY OFFER £299 !**

**NEW ! SIGMASIZER 200. A 2m. 200 channel frequency synthesised Transceiver. 10w. o/p, £165**

## 144 MHz EQUIPMENT

### TEMPO 2 METRE FM AMPLIFIERS

Model	Drive Power	Output Power	Current	Price
1002-3	5-25 watts	100-135 watts	17 amps	£119.90
802	5-12 watts	70-90 watts	12 amps	£98.97
502	5-15 watts	35-55 watts	5 amps	£57.95
TCP 12A CONTROL HEAD				£17.85

All the amplifiers operate on 13.8v. D.C.

Tempo brings you the finest amateur RF amplifier for VHF FM available today. Years of experience in solid state RF design have gone into the equipment to assure the highest degree of efficiency and reliability. Only state-of-the-art techniques in circuit and semiconductor technology make an amplifier of this quality possible. The amplifying transistors are of the balanced emitter silicon power type. These transistors are individually checked for power output and reliability during mis-match conditions, before being inserted in the amplifiers. Additionally the amplifying transistors are operated well within the factory's suggested limitations for added reliability and life. This assures the customer of years of dependable service even under the most punishing conditions.

All circuitry is of micro-strip technique for stability and broadband characteristics. Additional features of the micro-strip techniques include extreme mechanical stability and ease of servicing.

Antenna switching is accomplished through the use of specially selected pin diodes and printed quarter wave micro-strip transmission lines. These PIN diodes are activated by an RF sensing circuit consisting of a printed omni-directional coupler and amplifier. Thus when as little as .5 watt of RF power is applied to the input of the amplifier this circuit is activated causing the PIN diodes to switch this RF power through the RF power amplifier. During receive the antenna by-passes the amplifier and is fed through the PIN diode switch to the transceiver. Also of note is a reverse voltage protection diode. In the event the amplifier is connected to the wrong polarity, the diode will protect the power transistors from destruction.

All RF and DC cables are supplied along with a detailed instruction manual describing installation, circuitry, and service. All of the units are very simple to install and fool-proof to operate. With proper care these amplifiers will give you a lifetime of dependable service.

Commercial, type-accepted equipment is available for slightly higher prices. Those amplifiers include commercial quality filtering. All commercial orders should include a frequency range to which the amplifier should be tuned.

### TEMPO TCP 12A

This unit offers the user continuous monitoring of the power output of his amplifier. Power is read directly in watts on the meter. This head is plugged into the control jack of any Tempo amplifier. It can be mounted in any convenient location, away from, or next to the amplifier. It then offers the user not only power output monitoring but also the ability to turn the amplifier off and on. The control head can also monitor the battery voltage. Power is detected in the amplifier by a printed circuit directional coupler which is built into all Tempo TPL VHF power amplifiers.

## NEW ! SEIDENSHA 2m. FM-SSB power Amplifier. Type FMB200J, £160

- ★ Operates from 234v. A.C.
- ★ 100 watts OUTPUT !
- ★ Requires only 10w. drive.

- ★ Switchable for FM or SSB.
- ★ Regulated 12v. D.C. supply available to power FT-2FB, etc.

J BEAM EX-STOCK

## 430Z MHz EQUIPMENT

**MODEL TA-10CN.** 144-432 MHz Transvertor **£85.39.** This unit converts 144 MHz signal to 432 MHz. 10w. o/p and also converts the received signal to 144 MHz.

## ROBOT Slow-scan TV. Ex-stock

All you need to add to your SSB transmitter/receiver is the mode to monitor **£237** and Model 80 Camera **£262** in order to send and receive SSTV signals from around the world.

Please send SAE for full details.

## AMECO TRANSCEIVER PRE-AMPLIFIER. Model PT-E

Covers 1.8-54 MHz to give a boost to receiver signals. Automatically by-passed on transmit. Feed a second receiver. Powers transceiver and clock and has a spare A.C. outlet. Relays operate linear and receiver muting. Has 6CW4 Nuvistor RF stage for excellent noise figure. Price **£31.80** Ex-stock.

## NEW/USED EQUIPMENT

COLLINS 75S1, excellent ...	£175.00	HEATH, SB200, like 7 days old !	£99.00	LAFAYETTE HA350. V. good ...	£55.00
CODAR AT5 + A.C. + A.C. P.S.U. ...	£25.00	HEATH, Mohawk receiver	£59.00	LAFAYETTE HA600A. V. good ...	£39.00
CODAR Pre-Amp ...	£5.00	K.W. ATLANTA. NEW ...	£199.00	NATIONAL NCX5. Mint	£175.00
EDDYSTONE EC10 Mk. I, excellent	£35.00	K.W. ATLANTA. Good	£150.00	NATIONAL NCX500. Superb	£175.00
EDDYSTONE 750. V. good	£45.00	K.W. 201. V. good	£75.00	RACAL MA79G. Mint	£485.00
HALLICRAFTERS SX133 + SPEAKER.		K.W. 202. Mint	£119.00	TRISTOO 105ft. Teles. Tower	£225.00
Superb ...	£99.00	K.W. VESPA 2's. Excellent, several	£90.00	TRIO 9R59D. V. good	£30.00
HALLICRAFTERS HT328. Good	£80.00	K.W. P.E.P. Meter. Mint	£10.00	TRIO 9R59DE. Excellent	£30.00
HEATH, HW32A, excellent	£60.00	K.W. VICEROY 3	£65.00	TRIO 9R59DS. Excellent	£39.00
HEATH, HW100 + HP23 + SB600	£95.00	K.W. VICEROY 4	£80.00	TRIO IR310. Excellent	£60.00
HEATH, HW101 + HP23E	£95.00	K.W. 2000 + A.C. + D.C. Excellent	£150.00	TRIO IR500SE. V. good	£49.00
HEATH, SB101 + HP23E + SB600	£155.00	K.W. 2000A + A.C. P.S.U. Excellent	£149.00	TRIO TS510. Mint	£140.00
HEATH, SB101 + HP23E	£150.00	K.W. D.C. P.S.U. (KW2000A)	£20.00	YAESU FT-200. Superb	£135.00
HEATH, SB303 NEW + CWF assembled	£238.00	K.W. VF04B. Mint	£20.00	YAESU FT-200. Mint	£140.00
HEATH, SB303, mint	£150.00			YAESU FT-101 Mk. I	£199.00

## NEW ! ELECTRIC WINCH for Versatower, £49.75 (50p)

**ANTENNAS.** ASAHI, MOSLEY, HY-GAIN, J-BEAM, BANTEX, G-WHIP all in stock.

**EXPORT :** A pleasure ! We ship daily via LAND, SEA or AIR ! **STOP PRESS.** Due to currency fluctuations, prices are liable to alterations.

FOR COURTEOUS SERVICE CONTACT US AT

# WESTERN ELECTRONICS (UK) LTD.

OSBORNE ROAD . TOTTON . SOUTHAMPTON SO4 4DN . TEL : TOTTON (04216) 4930 or 2785

Cable : 'AERIAL' SOUTHAMPTON

# THE SENATOR CRYSTAL BANK

G3UGY

Phone 01-769 1639

## CRYSTALS FROM STOCK AT KEEN PRICES

**SENATOR CRYSTALS: the first place to contact when you need good crystals quickly.**

Here are just a few of the popular frequencies actually in STOCK now:

kHz		MHz	
100 in HC13/U ...	£2.50	28-045 in HC25/U ...	£1.60
454 in HC6/U ...	£1.75	28-500 in HC25/U ...	£1.60
455 in HC6/U ...	£1.75	30-000 in HC6/U ...	£1.60
456 in HC6/U ...	£1.75	32-500 in HC18/U ...	£1.60
500 in HC6/U ...	£1.75	34-000 in HC18/U ...	£1.60
		34-500 in HC18/U ...	£1.60
		35-000 in HC18/U ...	£1.75
		35-500 in HC18/U ...	£1.75
		38-666 in HC18/U*	£1.35
		40-000 in HC18/U ...	£1.60
		42-000 in HC18/U ...	£1.60
		70-000 in HC18/U*	£2.00
		71-000 in HC18/U ...	£2.00
		72-425 in HC18/U ...	£1.75
		72-500 in HC25/U ...	£1.75
		72-525 in HC18/U ...	£1.75
		96-000 in HC18/U ...	£2.00
		116-000 in HC18/U ...	£2.80

\* = Also in HC6/U

And here's our STOCK range of BRAND NEW HC6/U 8 MHz for 2M :  
8-002 8-007 8-012 8-018 8-021 8-0266 8-032 8-041 8-043 8-047 8-048 8-0555  
8-058 8-061 8-070 8-081 8-092 8-100 8-104 8-107

All at £1.25 each, post free.

The following frequencies may be suitable for your PYE Cambridge, Ranger, Vanguard, etc., etc. Check up with crystal multiplication data and crystal spec., in equipment manuals for suitability.

8-0555 MHz in HC6/U for TX x 18 =	145-000 MHz 2M Mobile	£1.25
44-7666 MHz in HC6/U for RX x 3 + 10.7 MHz =	145-000 MHz 2M Mobile	£1.80
8-100 MHz in HC6/U for TX x 18 =	145-800 MHz for RAEN	£1.25
45-0333 MHz in HC6/U for RX x 3 + 10.7 MHz =	145-800 MHz for RAEN	£1.80
12-975 MHz in HC6/U for RX x 12 =	10.7 MHz	
	145-000 MHz 2M Mobile	£1.60
11-1916 MHz in HC6/U for RX x 12 + 10.7 MHz =	145-000 MHz 2M Mobile	£1.60
12-0833 MHz in HC6/U for TX x 12 =	145-000 MHz 2M Mobile	£1.60
8-7825 MHz in HC6/U for TX x 8 =	70-260 MHz 4M Mobile	£1.60

29-780 MHz in HC6/U for RX x 2 + 10.7 MHz =	70-260 MHz 4M Mobile	£1.65
6-7466 MHz in HC6/U for RX x 12 =	10.7 MHz	
	70-260 MHz 4M Mobile	£1.60
11-710 MHz in HC6/U for TX x 6 =	70-260 MHz 4M Mobile	£1.60

### NEW FREQUENCIES FOR POPULAR CHANNELS :

44-593333 MHz in HC6/U for RX x 3 + 10.7 MHz =	144-480MHz F.M. Channel	£1.80
45-016667 MHz in HC6/U for RX x 3 + 10.7 MHz =	145-750MHz Repeater Out	£1.80
8-063888 MHz in HC6/U for TX x 18 =	145-150MHz Repeater In	£1.65
4-031944 MHz in HC6/U for TX x 36 =	145-150MHz Repeater In	£1.65
4-027777 MHz in HC6/U for TX x 36 =	145-000 Mobile	£1.65
4-013333 MHz in HC6/U for TX x 36 =	144-480MHz F.M. Channel	£1.65

### NEW FREQUENCIES now available :

1-6202 MHz and 1-6184 MHz in HC6/U (spacing 1.8 kHz) at	£1.80 each
33-6666 MHz in HC6/U ... ..	£1.60
43-333 MHz in HC18/U ... ..	£1.70
46-666 MHz in HC18/U ... ..	£1.70
47-3333 MHz in HC18/U ... ..	£1.70
48-3333 MHz in HC18/U ... ..	£1.70
58-000 MHz in HC18/U ... ..	£1.70
10-866667 MHz and 9-975 MHz in HC6/U (TX/RX crystals) for glider channel 130-400 MHz at ... ..	£1.70 each

Prices for specially manufactured SENATOR Crystals are as follows (made to Ministry of Defence Standards):

50—149.9 kHz in HC13/U ... ..	£4.60
150—499 kHz in HC6/U ... ..	£3.85
450—500 kHz in HC6/U ... ..	£3.50
501—999 kHz in HC1/U ... ..	£4.50
1-000— 1.39 MHz in HC6/U ... ..	£3.20
1.40 — 20.00 MHz in HC6/U (18/U & 25/U over 5 MHz) ... ..	£2.00
20.00 — 59.99 MHz in HC6/U ; HC18/U ; HC25/U ... ..	£2.25
60.00 — 79.99 MHz in HC6/U ; HC18/U ; HC25/U ... ..	£2.50
80.00 — 114.00 MHz in HC6/U ; HC18/U ; HC25/U ... ..	£3.00
114.00 — 140.99 MHz in HC6/U ; HC18/U ; HC25/U ... ..	£7.00
141.00 — 175.99 MHz in HC6/U ; HC18/U ; HC25/U ... ..	£8.75
176.00 — 200.00 MHz in HC6/U ; HC18/U ; HC25/U ... ..	£12.00

**V.A.T. ADD 10% TO ALL PRICES.  
APRIL 1st ONWARDS —**

Mail Order SENATOR CRYSTALS Dept. S.W., 36 Valleyfield Road, SW16 2HR

Latest FT-101 Transceivers, and full range of equipment from Stock. Checked (and adjusted where necessary) by experienced KW Engineers, before despatch. Your purchase of imported equipment is given professional care and attention. The most modern (and expensive) Test equipment in the Amateur Radio Trade, in this country, is available to our Engineers.

Usual KW courtesy and service. Easy terms available.

**K.W. Developments Ltd.**

1 HEATH STREET, DARTFORD, KENT

Telephone : Dartford 25574

**G3ACQ OFFERS: CRYSTALS: 65p each.**  
**YAESU MUSEN FT/FR.50, FT 75 ; TRIO JR310, 9R59DS, TS515. J BEAMS ; HY-GAIN VERTICALS ; KATSUMI KEYERS — JUNKERS KEY — STOLLE ROTORS ; DIGITAL CLOCKS** including tuning fork, battery operated types ; components.

**S. MAY (Leicester) LTD.**  
12/14 CHURCHGATE, CITY CENTRE,  
LEICESTER LE1 4AJ  
Telephone 58662

## TEN-TEC RX-10 — COMPACT, PORTABLE, 4-BAND RECEIVER

The Ten-Tec RX-10 is a rugged, solid-state receiver for 80-40-20-15 metre Amateur Bands. Dependable synchrodyne circuit converts signal directly to audio with dual gate MOSFET mixer. Assures freedom from "images and birdies". Sensitivity is high and frequency drift is negligible. The RX-10 features a built-in oscillator for code practice. Also makes a fine CW monitor when used with a suitable transmitter. Audio output drives high impedance headphones only. Rear switch for 230v. A.C. or 12v. D.C. operation.

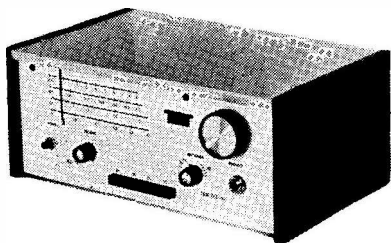

£32.50 (postage 30p extra)

### PERFORMANCE ;

Sensitivity : Less than 1 uv provides readable signal.  
Stability : Less than 100 Hz drift. No warm up.  
Audio Output: 3 volts across 1000 ohm load.

### SPECIFICATIONS ;

Frequency range : 80 3.5- 4.0 MHz  
40 7.0- 7.3 MHz  
20 14.0-14.6 MHz  
15 21.0-21.9 MHz  
Modes of operation : USB, LSB, CW, AM.  
Power : 230v. A.C. 50-60 Hz  $\frac{1}{2}$ A. or 12v. D.C. 35ma.  
Size : 10 $\frac{3}{8}$ "w. x 4 $\frac{1}{2}$ "h. x 6 $\frac{3}{8}$ "d.  
Controls : Band Selector (push-button).  
Audio gain, Antenna tune, Main tune.  
Power ON-OFF.  
Rear panel connectors : Antenna—phono socket.  
Key—phono socket.  
12v. D.C.—phono socket.  
Shipping Weight : Approx. 2 $\frac{1}{4}$  lbs.

Antenna impedance : 50-75 ohms—unbalanced.  
Circuit : Direct conversion. Synchrodyne.  
Selectivity : 2 kHz at 6dB down points.

## RADIO SHACK LTD. 188 BROADHURST GARDENS

LONDON, NW6 3AY

Open 6 days 9 a.m. until 5 p.m.  
Closed for lunch 1 p.m. until 2 p.m.

Just around the corner from West Hampstead Underground Station  
Telephone : 01-624 7174 Cables : Radio Shack, London, N.W.6.  
Giro Account No.: 588 7151 Access and Barclay cards accepted

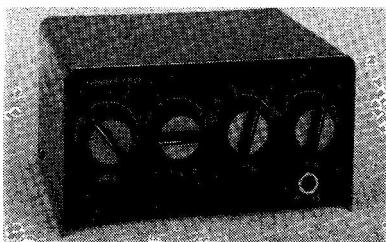

P M I I A

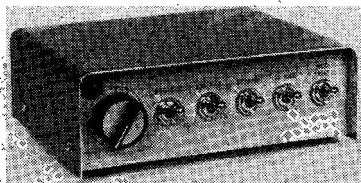

P M I X

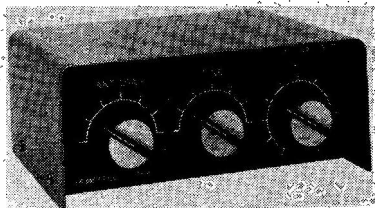

P M I I I

### PRESELECTORS

**P.M.IIA.** This is a preselector covering from 1.8 to 32 MHz in six overlapping ranges, having an antenna coupler to make the most of your aerial, followed by an EF80 to amplify the signal up to some 20/25 dB before it reaches the receiver. Complete with silicon/transformer fused supply and indicator. £9.20. Can also be supplied with a built-in 1 MHz crystal calibrator. £13.20.

**P.M.IIB.** A preselector covering from 1.8 to 32 MHz with antenna coupler utilizing an FET and Bipolar, battery powered. £8.25.  
The P.M.IIB can now be supplied with a gain control. £8.50.

**P.M.IIBX.** The mains powered version of the P.M.IIB. Having a transformer/silicon fused power supply with indicator. A gain control is included. Case size as P.M.IIB. £10.85.

### CALIBRATORS

**P.M.V.** Extremely small unit having a 1 MHz oscillator and 100 kHz I/C divider. Modulation applied at 1 kHz. £7.75.

**P.M.VIII.** Battery driven with outputs at 1 MHz, 100 kHz, 10 kHz and modulation at 1 kHz. Oscillator adjustable to a frequency standard transmission, again using I/C dividers. £11.75.

**P.M.IX.** Mains powered de luxe version of the above, having outputs at 1 MHz, 500 kHz, 100 kHz, 50 kHz, 10 kHz and again modulation at 1 kHz when required. It has a silicon/transformer fused supply, with indicator and gain control. £19.50. All these calibrators give harmonics up to at least 144 MHz.

### CONVERTERS

**P.M.III.** This is a 1.8 MHz converter, using FET's in R.F. and Mixer plus a Bipolar crystal controlled oscillator. I.F. at 7 to 7.2 MHz. Having an antenna coupler. Battery powered. £10.50.

**P.M.VI.** A preselector with same specification as the P.M.IIA with the addition of an FET 1.8 MHz converter again crystal controlled, with antenna coupler. £18.50. This can also be supplied with a built-in 1 MHz calibrator. £22.50.

Send for illustrated leaflets

**HAMGEAR ELECTRONICS**  
29 CARLYLE ROAD, NORWICH, NOR 66C

# WE ARE THE ANTENNA PEOPLE

## SOME ANTENNAS

impact

MONO-BANDERS			
A-310	3 Element.	10 metres	£24.00
A-315	3 Element.	15 metres	£25.00
Classic-203-C	3 Element.	20 metres	£70.00
A-92-S	9 Element.	2 metres	£11.50
DI-10	Ground Plane.	10 metres	£18.00
DI-2	Ground Plane.	2 metres	£6.50
MCQ-10	10 metre Quad		£45.00
MCQ-15	15 metre Quad		£45.00
MCQ-20	20 metre Quad		£48.00
DUAL-BANDERS			
Elan	3 Elements.	10 and 15 metres	£30.00
Elan	2 Elements.	10 and 15 metres	£22.00
TD-2	Trap Dipole.	40 and 80 metres	£23.50
TRI-BANDERS			
Mustang	3 Elements.	10, 15 and 20 metres	£44.00
Mustang	2 Elements.	10, 15 and 20 metres...	£33.00
TA-33 Jr.	3 Elements.	10, 15 and 20 metres...	£35.00
TA-32 Jr.	2 Elements.	10, 15 and 20 metres...	£24.50
TA-31 Jr.	Rotary Dipole.	10, 15 and 20 metres	£15.50
Classic-36	6 Elements.	10, 15 and 20 metres...	£98.00
Classic-33	3 Elements.	10, 15 and 20 metres...	£77.00
V-3 Jr.	Trap Vertical.	10, 15 and 20 metres	£11.00
MCQ-3B	Cubical Quad.	10, 15 and 20 metres	£70.00
Ei-Toro	Vertical.	20, 40 and 80 metres	£11.00
QUAD-BANDERS			
Atlas	Trap Vertical.	10, 15, 20 and 40 metres	£22.00
SWL Antennas			
SWL 77	Dipole.	11, 13, 16, 19, 25, 31 and 49 metres	£11.00
RD-5	Dipole.	10, 15, 20, 40 and 80 metres	£11.00

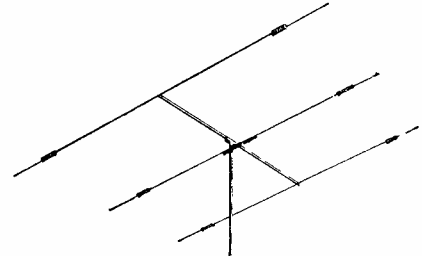

TA 33 Junior

Note: All "E" Models (2" mast fitting) ... Plus 50p  
 Note: All prices ex works carriage and Insurance extra.

Send for **HANDBOOK/CATALOGUE** containing full details of Antennas and other technical information. 25 pages 15p. Refundable upon purchase of Antenna.

# MOSLEY

## Electronics Ltd

40 Valley Road, New Costessey, Norwich,  
**NOR 26K, England.**

## R. T. & I. ELECTRONICS LTD.

where equipment is fully overhauled

KW VESPA 2 and p.s.u.	£105.00 (£3.00)
HEATHKIT GR 64	£25.00 (£1.00)
KW/GELOSO CONVERTER (into 4-5 MHz)	£16.00 (50p)
LAFAYETTE HA350	£60.00 (£1.50)
LAFAYETTE HA800	£48.00 (£1.00)
HEATHKIT RAI	£35.00 (£1.00)
LAFAYETTE HI 80	£50.00 (£1.50)
HAMMARLUND SP-600-JX6	£135.00 (£2.00)
EDDYSTONE 770U	£160.00 (£2.00)
HEATHKIT DX 100 Transmitter	£45.00 (£3.00)
EDDYSTONE EC10 Mk. 2	£68.00 (£1.00)
KW 2000A with A.C. p.s.u.	£180.00 (£3.00)
NATIO NAL NCX-5 with A.C. p.s.u.	£220.00 (£3.00)
TRIO TS 510 with A.C. p.s.u.	£150.00 (£3.00)
EDDYSTONE 960 Receiver	£120.00 (£2.00)
KW 201 Receiver	£90.00 (£2.00)
HEATHKIT RGI Receiver	£33.00 (£1.00)
TRIO JR-500-SE Receiver	£58.00 (£1.50)
RCA AR88D Receiver	£75.00 (£2.00)
TW 160 Communicator 12v. D.C.	£48.00 (£1.50)

WE CAN ALSO SUPPLY ANY MAKE OF NEW EQUIPMENT—and have pleasure in giving a few examples which are normally in stock:—

**STOCKISTS OF YAESU MUSEN EQUIPMENT.**  
**AVOMETERS.** Model 7, Mk. 2, £37.60; Model 8, Mk. 5, £40.90; Model 9, Mk. 4, £40.90; Model 40, Mk. 2, £37.60; Model 72, £18.20; Multimeter, Mk. 4, £13.59; Standard leather carrying case (Models 7, 8, 9, 40), £6.50; Every-Ready ditto, £7.40; Multimeter leather case, £3.30; 10KV D.C. Multiplier for Model 8, 9, £6.10; 30KV D.C. ditto, £9.90; Pair of Long Reach Safety Clips, £1.50; Models EAY13 Electronic Avd £82.00. All above post free in U.K. Trade and Educational enquiries invited.  
**S. G. BROWN'S HEADPHONES.** Type "F" 120 ohms, 2,000 ohms, 4,000 ohms, £5.90 (25p); Rubber earpads for same, 45p per pair (5p). Type 3C/1100 Noise excluding (with superb fitting), high quality, electro dynamic, £7.55 (25p). Standard Jack Plug, 24p (4p).  
**EDDYSTONE EQUIPMENT.** Receivers, R307, £389.00; EC10/2, £86.00; 1000, £210; 1001, £230; 1002, £293; 1004, £280; 924 A.C. mains p.s.u., £7.75 (50p); Doublet Aerial, 731/1, £7.50 (50p); Plinth Speaker, 905, £6.20 (50p); General Purpose Speaker, 935, £5.55 (40p); Edometer, 902 Mk. 2, £29.50 (50p); Telesopic Aerial, LP.3126, £2.50 (25p); Die-cast Boxes from 45p (10p). Brochure on request.  
**CODAR EQUIPMENT.** CR70A, £27.50 (65p); PR30X, £9.50 (30p); PR40, £8.90 (30p); Leaflets on request.  
**LAFAYETTE HA600 Receiver** £50.00 (50p).  
**LAFAYETTE HA800, £57.50 (50p).**

Carriage for England, Scotland and Wales shown in brackets. Terms: C.W.O., Approved Monthly Accounts, Hire Purchase and Part Exchange. Special facilities for export. Enquiries invited.

At R.T. & I.

- ★ We have full H.P. facilities.
- ★ Part exchanges are a pleasure.
- ★ We purchase for cash.
- ★ We offer a first-class overhaul service for your electronic equipment, whether you are an amateur or professional user.
- ★ We have EASY Packing facilities.
- ★ We welcome your enquiries for specific items which although not advertised, may very well be in stock.

**FREE SHURE MIC. WITH EVERY KW TRANSMITTER or TRANSCEIVER purchased**

**PARTRIDGE "JOYSTICKS,"** "New Lightweight VFA" £11.00 (40p).  
**"JOYMATCH" III.** Aerial Unit, £11.00 (40p). LO-Z500, £16.00 (40p); AU kit, £4.50 (30p); ATU assembled, £5.50 (30p); Artificial earth £4.50 (30p); Aerial Bandswitch, £4.50 (30p). Literature on request.  
**TRIO EQUIPMENT.** Receivers: 5R59DS, £49.50 (£1.00); JR 310, £75.00 (£1.00); JR 599, £185.00 (£1.50); Transmitter TX-599, £185.00 (£3.00); Transceiver TS 515 and PS 515, £210.00 (£3.00); Loudspeaker SP5D, £4.50 (50p); Headphones HS4 (equivalent), £6.00 (20p); Stabiliser, 60p (5p). Leaflets available.  
**SHURE MICROPHONES.** 444T, £15.00 (40p); 444, £13.00 (40p); 401A, £6.50 (30p); 201, £5.40 (30p); 202, £6.00 (30p). Full details on request.  
**KEYNECTORS,** piano key mains connector units, £2.95 (25p).  
**VALVES.** Please state your requirements.  
**ADVANCE DM22 DIGITAL MULTIMETER,** £99.00 (50p), etc., etc  
**TMK METERS:** TMK500, £9.00 (25p); TW20CB, £11.25 (25p); TP5SN £6.25 (25p); 700, £18.00 (25p); also leather cases.  
**PHILIPS PM2403 ELECTRONIC MULTIMETER,** £49.00 (25p), etc., etc. We also supply **PHILIPS and KORTING COLOUR TV TEST EQUIPMENT,** including Colour Bar Generators, Converters, etc.  
**KW EQUIPMENT (Don't forget your FREE mic. with every Tx. and Txcr.!).** KW2000B + A.C. p.s.u., £240.00 (£2.00); D.C. p.s.u. for KW2000B, £44.00 (50p); KWV 2000B only, £200.00 (£1.50); KW2000E plus A.C. p.s.u., £265.00 (£3.00); KWV ATLANTA + A.C. p.s.u., £190.00 (£2.00); Remote V.F.O. for Atlanta, £34.00 (50p); VOX unit for Atlanta, £7.50 (25p); Remote V.F.O. for 2000B, £36.00 (50p); KW1000 Linear amplifier, £135.00 (£1.50); KW202 Receiver with calibrator, £140.00 (£1.50); KW 202 Matching speaker, £8.00 (80p); KW204 Transmitter, £160.00 (£2.00); KW107 combined E-Z Match; VSWR indicator, dummy load and ant. switch (4 outlets) 52 or 75 ohms, £46.00 (50p); KW103, VSWR and power meter, 52 ohms, £12.50 (45p); KW101, VSWR meter, 52 and 75 ohms, £8.25 (30p); also E-Z match, dummy load, trap dipoles etc., etc. Details on request.

## R. T. & I. ELECTRONICS LTD.

Ashville Old Hall, Ashville Road, London, E11 4DX Tel: 01-539 4986



# AMATEUR ELECTRONICS G3FIK

BIRMINGHAM 021-327 1497 021-327 6313

MEMBER OF THE AMATEUR RADIO RETAILERS ASSOCIATION



## THE LAST CHANCE BEFORE VAT !

When this appears in print there will be approximately one month remaining before ALL Amateur equipment and accessories go up in price by perhaps 10%. What is not generally realised is that second-hand gear will also be affected so that this is the last time that our advertisement will show tax-free prices and, consequently, this is your very last opportunity to beat VAT. On the face of it, it seems only fair that Amateur gear should be taxed in line with everything else but it is conveniently overlooked that Amateur equipment is far too expensive in any event due, of course, to the relatively tiny market which does not permit mass production in the TV/BC Radio sense. Anyway the die is cast so presumably we must grin and bear it.

At the time of going to press we have a good variety of used equipment with other items en route, plus the full range of TRIO, SOMMERKAMP/YAESU and K.W. EQUIPMENT, together with an excellent range of Aerials, Rotators and accessories of every description.

IF YOU WOULD LIKE FULL ILLUSTRATED DETAILS OF ANYTHING BY THE ABOVE MANUFACTURERS LET US HAVE A REASONABLY LARGE STAMPED ADDRESSED ENVELOPE.

CREDIT TERMS : These are available on anything over £25 (10% deposit) and provided that you are able to give satisfactory proof of identity we are able to arrange an on-the-spot transaction which means you may have immediate possession of the goods without prior arrangement.

PART EXCHANGES : Thanks to our high turn-over in used equipment we welcome these and equally we buy outright for cash. If you have surplus or redundant gear please drop us a line stating condition, etc.. and price required.

**YAESU FTDX-560 TRANSCEIVER.** Absolutely mint condition ... £160.00  
**SOMMERKAMP FTDX-150 TRANSCEIVER.** Excellent ... £145.00  
**COLLINS 75-A2 RECEIVER.** Typically Collins in performance ... £82.50  
**HAMMARLUND HQ145 RECEIVER.** Double conv. General coverage ... £67.50  
**HAMMARLUND HQ180AX RECEIVER.** A superb general coverage set ... £145.00  
**KW201 RECEIVER.** Excellent condition and performance ... £81.50  
**KW VESPA Mk. 1 TRANSMITTER** with excellent HB PSU ... £81.50  
**SWAN 260 TRANSMITTER.** Absolutely new throughout ... £150.00  
**KW1000 LINEAR.** Another excellent little-used item ... £105.00  
**TRIO JR-310 RECEIVER.** As new with full guarantee ... £66.50  
**TRIO 9R59-DE RECEIVER.** Excellent clean condition ... £36.50  
**TRIO 9R59-DS RECEIVER.** Indistinguishable from new... £41.50  
**TRIO JR-310 RECEIVER.** An excellent buy at ... £60.00  
**HEATH GR-78 RECEIVER.** Choice of two, both unmarked ... £65.00  
**TRIO TS-500 TRANSCEIVER** with PS-500 and VFO-5. Excellent ... £135.00  
**TRIO TS-500 TRANSCEIVER** with PS-500 and VFO-5. Very good ... £130.00  
**GEC RC-410 RECEIVER.** Digital read-out ... £275.00  
**KW2000 TRANSCEIVER.** First-class condition ... £150.00  
**HALLICRAFTERS SR500 TRANSCEIVER.** 500 watts input ... £135.00  
**TRIO JR-500 RECEIVERS.** Choice of three from ... £45.00  
**HEATH SB300 RECEIVER** with SB600 speaker. Fitted CW filter also ... £95.00  
**PLEASE NOTE !** Our used equipment stocks are continually changing, at S.A.E. will bring you our latest list.

As announced last month we are now stocking the most popular items in the MOSLEY ANTENNA RANGE details as below. FULL RANGE OF AERIALS, CABLE AND ACCESSORIES AS SHOWN BELOW.

<b>Osker Block SWR200 Power Meters.</b> The ultimate in SWR/Power Bridges ... £19.25	<b>TCC SWR/Power Bridges C3005.</b> Twin meter model ... £7.85
<b>TCC SWR Bridges C3042.</b> Single meter model ... £5.00	<b>Sansai Miniature SWR/Power Meter SE406</b> ... £3.80

**Medco Filters.** The best on the market.  
 FL50A and FL75A 50 ohm Belling Connectors ... £6.00  
 FL50B and FL75B 75 ohm PL259 Connectors ... £6.50  
 FH40 High Pass ... £2.35

### Copal Clocks

All types ex stock. Illustrated list by return.

**Amphenol PL259 Connectors** ... ea. 30p  
**Belling Coaxial Connectors** ... ea. 10p

**50 ohm Heavy Duty Coax** ... yd. 22p (carriage extra)

### J. Beam Antennas.

Illustrated catalogue on receipt of S.A.E. Full range in stock.

**G-Whip Antennas** all ex stock, catalogue by return.

### Shure Microphones

Model 201 Hand ... £5.75  
 Model 444 Desk ... £13.25 (S.A.E. with enquiries please)

**Mosley Antennas**  
 TA31 Jnr. ... £15.50  
 TA32 Jnr. E ... £25.00  
 TA33 Jnr. E ... £35.00

### Hy-Gain Antennas

12-AVQ Vertical ... £16.50  
 14-AVQ Vertical ... £24.50  
 18-AVT/WB Vertical LC-80Q Loading coil... £7.50  
 TH3 Jnr. 3 ele. beam... £51.50  
 TH3 Mk. III 3 ele. beam ... £75.00  
 TH6 DXX 6 ele. beam ... £97.00  
 BN-86 Balun ... £8.00 (Carriage extra on Mosley/Hy-Gain)

### Rotators. All post paid.

Stolle Memomatic 3001 ... £22.40  
 Stolle Automatic 2010 ... £28.00  
 CDE AR20 ... £20.40  
 CDE AR22 ... £25.65  
 CDE TR44 ... £45.75  
 CDE HAM-M... ... £70.80

### Wightraps

Standard pairs ... £2.90  
 High Power ... £3.90

**NEW !** We are pleased to announce a Home Demonstration Service for the serious enquirer on all items of NEW communications equipment advertised. For Southern customers this is available by arrangement with our Southern Representative Jeff Harris G3LWM, Cricketfield Lane, Bishop's Stortford, Tel : 0279-56347. At the same time it will be of interest to Northern customers to hear of the appointment of John Rowley, G3KAE as our Northern representative. John is located at Castle Rise, West Ayton, Scarborough, Yorks. Tel : West Ayton 3039 and similarly he is equipped to home demonstrate all new gear if you are seriously contemplating purchasing and if you are within reasonable distance.

**PLEASE NOTE—Both G3LWM and G3KAE are NOT part-timers, available only at certain hours of the day. REMEMBER—THIS IS THE ONLY WAY TO BUY EXPENSIVE GEAR IF YOU CAN'T GET IN TO SEE IT IN THE SHOWROOM.**

**ALL ITEMS OF EQUIPMENT AND ACCESSORIES ARE PRICES TO INCLUDE CARRIAGE/POSTAGE UNLESS OTHERWISE STATED. PRIVATE CAR PARK FACILITIES FOR THE CALLER**

**ELECTRON HOUSE, 508-514 ALUM ROCK ROAD, BIRMINGHAM. 8.**

25p

# *The* SHORT WAVE *Magazine*

VOL. XXXI

MARCH, 1973

NUMBER 1

for  
the  
radio  
amateur  
and  
amateur  
radio

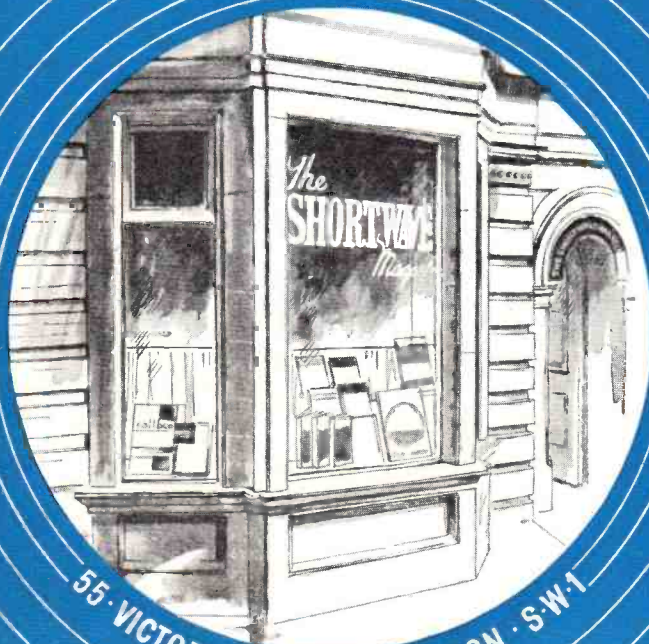

55-VICTORIA STREET · LONDON · S.W.1

# LOWE ELECTRONICS

**119 Cavendish Road, Matlock, Derbyshire, DE4 3HE**

**Tel. Matlock 2817 or 2430 9 a.m. - 9 p.m.**

**John: G3PCY**

**Bill: G3UBO**

**Alan: G3MME**

**Hours:** Tuesday to Saturday 9-5.30 (closed for lunch 1-2 and all day Monday).

**Service and Sales:** A good range of our equipment is available (evenings and weekends only) at the following: John G3JYG, 16 Harvard Road, Ringmer, Lewes, Sussex. Tel: Ringmer 812071. Sim GM3SAN, 19 Ellismuir Road, Baillieston, Nr. Glasgow. Tel: 041-771 0364. Alan GW3YSA, 35 Pen y Waun, Efail Isaf, Nr. Pontypridd, Glam. Tel: Newton Llantwit 3809. Peter Ward G3XWX, 47 Radstock Avenue, Ward End, Birmingham, B36 8HD.

**Service only** (evenings and weekends): Dave Dryden G3BKQ, 205 Main Street, Thornton, Leics.

*MAIN DISTRIBUTORS FOR YAESU MUSEN EQUIPMENT*

In addition to our range of equipment covering all the needs of the Amateur, we would like to mention just three new products.

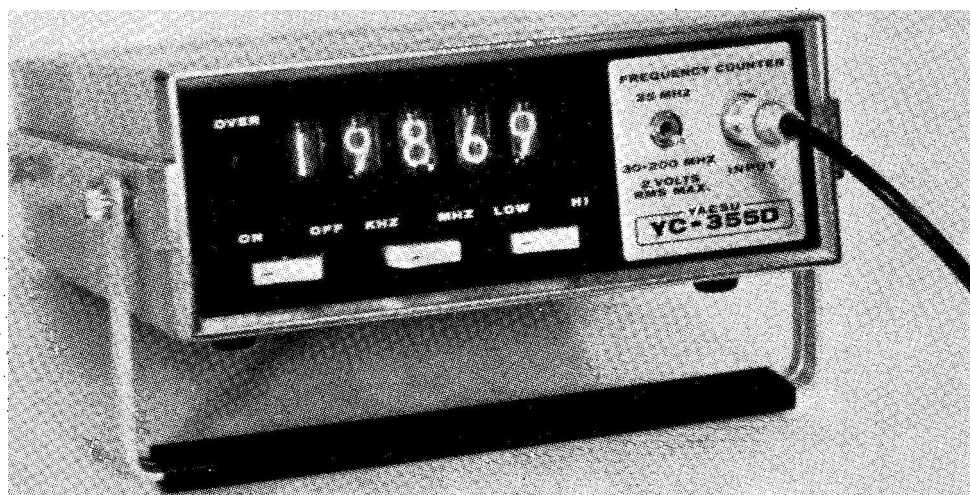

## **YC-355D Counter**

Reads to at least 200 MHz

Battery or mains

**£111 plus V.A.T.**

At around 50p a Meg, the YC-355D is streets ahead.

# SOLID STATE MODULES

Telephone: 0484 - 23991

63 WOODHEAD ROAD,  
SOLID, LOCKWOOD,  
HUDDERSFIELD, HD4 6ER

MEMBER OF THE AMATEUR RADIO RETAILERS ASSOCIATION

PLEASE NOTE ALL OUR EQUIPMENT WILL CARRY 10% V.A.T. AFTER 1st APRIL

## NEW! SSM EUROPA 10 METRE TO 2 METRE SSB TRANSVERTER

Orders for this equipment have been so good that at the moment (January) we cannot assure an ex-stock supply at press time. But we can say that orders received during this month will save the 10% V.A.T. which will be added to all our products next month. The unit plugs straight into YAESU/SOMMERKAMP gear. The receive converter specification is the same as below. The transmitter converter uses valves, two QQV03/10 and QQV06/40 P.A. and is rated at 200W P.E.P. input. Price £58.50 less valves—we find that many people have the valves available but we can supply them at £1.25 each, QQV03/10, and £10.00, QQV06/40.

NEW! We have now a very comprehensive stock of J Beam aerials and rotators.

## NEW! 3CG CRYSTAL CONTROLLED CALIBRATION GENERATOR

1 MHz 100 kHz 10 kHz outputs, all easily received up to UHF. No unwanted outputs. Internal stabilised mains. P.S.U. or external battery operation. Size: 4½" x 1½" front panel ¾" deep. Ideal for H.F. or V.H.F. use. Price: £16.00.

## SPECIFICATION COVERING ALL OUR VHF CONVERTERS

- ★ Noise figure 2 dB. Gain 30 dB.
- ★ Dual gate MOSFETs in RF and mixers for excellent overload and cross modulation characteristics.
- ★ All housed in aluminium cases, stove enamelled silver hammer with black trim.

## THE SENTINAL 2 METRE OR 4 METRE DUAL GATE MOSFET CONVERTER

By far the most popular converters. Stock IFs for 2 metres: 2-4 MHz, 4-6 MHz, 9-11 MHz, 14-16 MHz, 18-20 MHz, 23-25 MHz, 24-26 MHz, 27-29.7 MHz, 28-30 MHz. 4 metre IFs: 4-4.7 MHz, 28-28.7 MHz. Size: 2½" x 3" x 1½" except the 2-4 MHz and 4-6 MHz which being double conversion are 2½" x 4" x 1½". Price £13.75.

## THE SENTINAL M.F.

Receives 2 metres on a conventional M.W. B.C. receiver, particularly useful for use with a car radio. IF output 0.5 to 1.5 MHz for 144-145 and 145-146 MHz into switched bands. "OFF" position switches M.V. aerial straight through to receiver. Double conversion design with two switched crystal oscillators. No frequency multiplication. Size: 5" x 1½" front panel 4" deep. Price: £18.75.

## Now becoming very popular: THE SENTINAL X DUAL GATE MOSFET 2 METRE CONVERTER

This 2 metre converter is a de luxe version of our well established Sentinel converter. Contains internal mains power supplier but can be used with external batteries. It features an RF gain control to reduce cross modulation and overload of the mains receiver and may be switched between mains and battery. Size: 5" x 1½" front panel 4" deep. It uses fundamental crystals on the required frequency i.e. no multiplication.

IFs from stock: 4-6 MHz, 2-4 MHz, 27.7-29.7, 28-30 MHz. Price: including P.S.U., £19.50.

Want to improve your present 2 metre receive system?

## THE SENTINAL LOW NOISE FET 2 METRE PRE-AMPLIFIER

- ★ Low noise figure 1 dB. Transistors selected for low noise figure.
- ★ Gain 18 dB, 12v. D.C. at 5 mA. Isolated supply lines.
- ★ Very good for bringing converted business gear up to scratch. Also helps IF breakthrough by increasing the wanted 2 metre signals and gives greater selectivity. Price: £6.50.

Want to receive 70 cms. cheaply but well?

## SM70 70 cms. CONVERTER

- ★ Low noise figure 4.5 dB.
- ★ IF output 144-146 MHz. By using the 70 cm. converter with a 2 metre converter you can have a high performance 70 cm. unit at low price £13.75.

**SPITFIRE 2 METRE A.M. TRANSMITTER**—5 watts input, £22.00, matching modulator, £10.00. T.B.C.I. Top Band to Medium Wave converters. £7.50.

**SOLID STATE 9 MHz GENERATOR**—£11.00 less filter and crystals, £25.00 with XF-9A filter and USB and LSB crystals.

## SECOND-HAND GEAR

KW200B, £165.00; KW202, £110.00; Eddystone 750, £40.00. Yaesu Musen equipment from stock, KVG 9 MHz filters, Plessey SL600 series ICs and other components as previously advertised, in stock. We believe that all units and components advertised will be ex-stock, but you can always ring for confirmation. Call in any time to have a look at the stuff. G3MXG.

**8 WAVEBANDS**—The most exciting radio ever! Picks up ALL THE USUAL BBC Programmes "All the new local radio stations" Continental "World-wide transmissions" "Pop Pirates" "Radio Hams" "Aircraft" "Shipping" "Police" "Taxis" "R.A.C." "A.A." "Fire Brigade" "T.V. Sound" "Ambulances and 1,000s more. THE BEST PORTABLE RADIO EVER MADE! We think so. What radio priced at under £120 gives you such a varied choice of transmissions? As well as the standard long and medium wavebands it has three short wave bands (including the Marine and Traveller Band) AND NO LESS THAN THREE V.H.F. BANDS—truly a complete WORLD-WIDE communications Receiver. JUST THINK! One minute you can be listening to your favourite B.B.C. programme and then—at the flick of a switch—you can tune into the control tower and hear a "crippled airliner" being talked down to safety. Or listen to the trawlers and ocean-going liners—Evesdrop on the taxicabs, fire brigades, ambulances, A.A., R.A.C. and 100s of other R.T. mobiles—even your local police! Extensive shortwave coverage can give you Australia, America, Far East, etc., etc., you name it—it gets it! Manufactured by specialists in communications and TV equipment, each set carries a FULL 3-YEAR WRITTEN GUARANTEE. Beautifully finished in Teak Wood and Stainless Steel—will add distinction to any living-room. Completely portable 12" x 9" x 4", using standard batteries—or can be plugged directly into mains. 14 transistors, 6 diodes, 1 thermister, internal ferrite rod aerial PLUS two external telescopic antennae—with sockets for additional aerials. Complete with beat frequency oscillator for the real enthusiast, or car aerials. Automatic Drift-Free Reception. Tone control. Fine squelch control. Hi-Fidelity earphone for Private listening, local DX switch. FREQUENCIES: Long W 150-350 kcs. Medium W 540-1605 kcs. Marine 1-6.4Mc/s. Short W1 3.7-9 Mc/s, Short W2 9-22 Mc/s. F.M. (VHF) 88-108 Mc/s. Aircraft (VHF) 108-136 Mc/s. Public Service (VHF) 148-174 Mc/s. THE ULTIMATE in communications receivers—used by professionals and amateur enthusiasts all over the world. INSTANT CASH REFUND if not overwhelmed by the superb tone clarity and performance range.

NOT JUST A RADIO BUT A COMPLETE COMMUNICATIONS RECEIVER  
**BATTERY/MAINS PORTABLE RECEIVER**

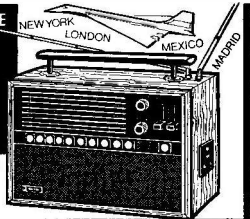

WHAT RADIO PRICED AT UNDER £120 GIVES YOU SUCH A VARIED CHOICE OF TRANSMISSIONS?

CASH PRICE **£49.50** 4-50p P & P or £14.50 dep. + 50p P & P & 6 months at £7 (£56.50)

**PROFESSIONAL**  
ENQUIRIES FROM SMALL PROFESSIONAL & AMATEUR ASSOCIATIONS CLUBS ETC. WELCOME  
**COMPLETE SYSTEM**  
**£51.75**  
+ 25p p. & p.

# 2 CHANNEL WALKIE-TALKIE SYSTEM

UP TO 8 MILES RANGE  
TRANSMITS & RECEIVES

**JUST ARRIVED**—a fabulous NEW system from Switzerland—the home of precision electronics. We've snapped up a very limited quantity of these GENUINE 2-WAY WALKIE-TALKIE SYSTEMS. Ideal for outdoor crowd control, doctors in outlying areas, fishermen and general marine use, etc. The telescopic antenna pulls in the voice at the other end with crystal clear clarity—even at a distance of 8 miles! Frequency 29.9 Mc/s. (this is interchangeable according to your licence stipulation). Battery operated—no wires. A tremendous time and money saver. 2 Units complete with FREE carrying cases. Credit terms available on request.

NOTE: Licence is required to operate.

N.B.—THE MINISTRY OF POSTS & TELECOMMUNICATIONS HAS POINTED OUT THAT A LICENCE (NOT GENERALLY AVAILABLE TO THE PUBLIC) IS REQUIRED FOR RECEPTION OF TRANSMISSIONS BY FIRE BRIGADE, AIRCRAFT, SHIPPING, etc., BUT THERE IS NO LICENCE NEEDED TO BUY.

SEND 5p STAMP FOR COMPREHENSIVE BROCHURE OF UNUSUAL FREQUENCY RADIOS

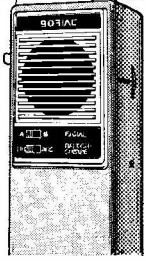

**SCIENTIFIC & TECHNICAL (Dept SW/2) TOWERFIELD TRADING ESTATE, SOUTHEND, ESSEX**  
Callers welcome at: 507-511 LONDON ROAD, WESTCLIFF, ESSEX. & 186 TOTTENHAM CT. RD., W.I.

# NORTH WEST ELECTRICS, G3MAX

769, STOCKPORT ROAD, LEVENSHULME,  
MANCHESTER, 19.

Phone: 061-224 4911

**EDDYSTONE RECEIVERS & DIECAST BOXES.  
TRIO RECEIVERS. JACKSON CAPACITORS &  
DRIVES. DENCO COILS.**

INTEGRATED CIRCUITS AND COMPONENTS FOR FREQUENCY COUNTERS AND CLOCKS.

**NEW TEXAS I.C.'s.** 7400, 22½p; 7413, 40p; 7490, 86p; 7474, 45p; 74141, £1.12; 7475, 55p; 72710, 46p; 72741, 75p. Post 5p each.

Holders for IC's low profile 14 or 16-pin, 15p each, postage 5p each and including 5 off.

**READOUT TUBES.** ZM1020 1" dia. end viewing, £1.50 each with holder, 4 for £5, post paid. GNP7 or A7001 wire-ended tubes, £1.50, post 5p.

**DIGITAL CLOCK BOARD.** 4 digit 12 hour. Uses 7 off SN7490's. 1-SN7413, 3-SN74141, 1-C407. Printed to use A7001 midget side viewing tubes. £1.50p. Post 5p.

ALL BOARDS ARE HIGH QUALITY PRINT ON FIBRE GLASS. HOLDERS FOR I.C.'s. Low profile 14 or 16 pin, 15p each, postage 5p each and including up to 5 off.

**8 DIGIT READOUT BOARD ASSEMBLY, £4.50, post 10p.** Printed to use ZM1020 1" dia. end readout tubes. Front board takes holders for ZM1020s and 74141N Nixie drivers. Back board takes 7490 and 7475 Quad latch. Boards mount back to back to make an ideal assembly for frequency counter, etc. Board size 10" x 2½".

**PRINTED CIRCUIT HOLDERS FOR ZM1020, 28p each, post 5p.** 8-way ribbon cable for connecting boards, 20p yd., post 5p. yd. (8 for 4" sections required for linking boards.)

**PRINTED BOARD FOR 7271 ON op amp.** Counter front end. 2½" x 1¼", 45p, post paid.

**PRINTED CIRCUIT BOARDS, £1.50 each, post 5p.** READOUT BOARD. 4 Digit, uses GNP7 wire-ended, side viewing tubes. 7490 dividers, 7475 latch and 74141 Nixie driver. Printed for reset 0, can be wired to reset 9. Size: 4½" x 3".

**TIME BASE BOARD.** Gives all pulses needed to control readout for counter. Uses 7400 Osc. 1 MHz. 6 off 7490 Divider chain to 1 cycle. 7474 clocked dual D, 7413 Schmitt trigger. 7400 pulse outputs. 2N3703 latch output. Size: 4½" x 2½".

**MODULATOR, TYPE 105.** Ex-TR 1986 series. 2-6C4 in push pull. EF92 Mic. amp. EL91 driver, with circuit, 75p, post 25p.

**CONTROL UNIT, TYPE 384.** This unit contains: 3½" desyn indicator, 5 mA right hand zero meter 1½" dia. 6-var. res. with gear drive on 2-2 DP push buttons. 2-1-pole 12-way, 1-8-pole 5 way, 2 bank switches. 3-62, 2-42 ohm 5W res. Excellent value, 87½p, post 27½p.

**IF STRIP.** Ex R3673 Rx. 7.5 MHz with circuit. Less valves. 8 B7G PTFE holders. Sealed relay twin 500 ohm coil. 12-pin plug and socket, 50p, post 20p.

**CONVERTER 20 to 90 MHz.** 7.5 MHz IF. Ex 3673 Rx. 2/EF91's. 1-6J6 Osc., £1.25, post 20p. Some less valves, 75p, post 20p.

**TRANSFORMER.** Specially wound for Digital instruments. 200 volt 40 mA HT. 6 volt 1A. Two windings LT. Will supply 6v. 2A. or 12v. 1A. CT 2½" x 2" x 2½", £1.50, post 25p.

**CV416 (6F17) VALVE, 30p each, post 5p, or 4 for £1.20, post paid.**

**INSTRUMENT CONTROL KNOBS.** Black with bright Ali. centre, ½" brass insert with grub screw. 1", 1½" and 1¾" dia., 15p each, post 5p each. Any excess refunded.

**DIECAST BOXES.** With fitted lid. Post 10p per box.  
Cat. No. 7969P 3½" x 1½" x 1 7/32", 39p  
Cat. No. 7134P 4½" x 2½" x 1", 46p  
Cat. No. 6909P 4½" x 3½" x 2", 65p  
Cat. No. 6827P 7½" x 4½" x 2", £1.04  
Cat. No. 6357P 7½" x 4½" x 3", £1.13

Sizes shown are approx. internal dia.

**ALI. MINI BOXES.** With fitted lid. Post 5p per box.

3" x 2" x 1", 33p      5½" x 4" x 1½", 43p  
4" x 2½" x 1½", 38p      4" x 2½" x 2", 38p  
4" x 4" x 1½", 38p      5" x 2½" x 1½", 38p

**FINNED ALUMINIUM HEAT SINKS.** 5" x 2" ready drilled for TO3, 25p. 5" x 4" undrilled, 37½p. 5" x 8", undrilled, 65p, post 10p.

**POLYPROPYLENE ROPE.** 500lb Strain. 100yd. reel. £1. post 15p. (This item is now in stock).

**Business Hours :** Tuesday-Friday, 9.30 a.m. to 6.00 p.m.

SATURDAY : 9 a.m.-5 p.m. OPEN ALL DAY

CLOSED ALL DAY MONDAY

WE WELCOME ALL ENQUIRIES HOWEVER SMALL

Stamped address envelope please for special offer list.

MEMBER OF THE AMATEUR RADIO RETAILERS ASSOCIATION

# EHELDFORD COMMUNICATIONS

11 BROADWAY, KINGSTON ROAD, STAINES, MIDDX.

Telephone: Staines 54401 & 51176

MAURICE STANSFIELD (G8DNM) RAY BOWDEN and the rest of the staff here are available from 9 a.m. to 6 p.m. every day except Thursday, when the hours are 9 a.m.-1 p.m. and Sunday when we are closed all day. Your queries regarding your radio and electronic requirements either by mail, telephone, or a personal visit will receive most careful attention and what we may not have actually in stock can usually be obtained. We are now in close contact with most suppliers of equipment and maintain constant stocks of the following :

**TRIO**

9R59DS Receiver ... ..	£49.50
JR310 Receiver ... ..	£75.00
JR599 Receiver ... ..	£185.00
TX599 Matching Transmitter to JR599 ...	£185.00
TR2200 2M Personal Transceiver ... ..	£62.50
SP5D Communications Loudspeaker... ..	£4.50

**J. BEAM**

- VHF/UHF Aerials
- Mast clamps and accessories
- Stolle Rotators.
- SENTINEL CONVERTERS AND PRE AMPS
- K.W. ELECTRONICS**
- RANGE OF EQUIPMENT.
- CODAR RECEIVERS AND PRESELECTORS** Etc.

**MICROWAVE MODULES**

144 MHz Transistor Receiver ... ..	£35.00
144 MHz 5 watt AM Transistor Transmitter ... ..	£32.50
Mosfet converters for 50, 70 and 144 MHz ... ..	£15.50
432 MHz Mosfet Converter ... ..	£18.50
432 MHz Varactor Multiplier ... ..	£17.50

At the present time all these items are ex stock, and we are now the main agents in the South of England for all Microwave Module products.

Eagle, T.T.C., Jacksons, Chassis, Diecast and Aluminium Boxes, PLUS large stocks of used and reconditioned transmitters and receivers.

EASY CREDIT TERMS AND PART EXCHANGE TRANSACTIONS ARE EASILY ARRANGED

If you are able to visit our premises any equipment you may be interested in we will willingly demonstrate to you

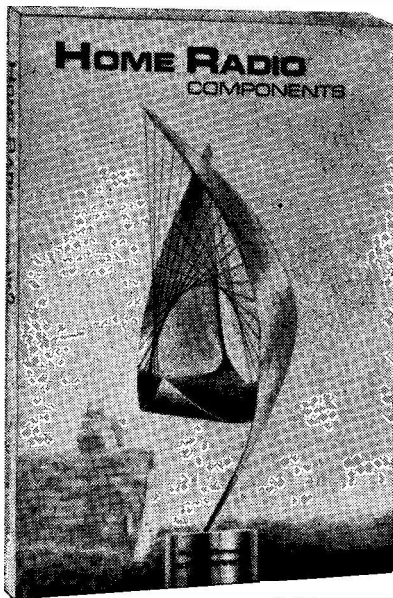

- 250 pages 11 1/4" x 8 1/4"
- Over 6,785 electronic components clearly listed and indexed
- 1,750 pictures
- 10 free Vouchers each worth 5p.
- Price list regularly updated
- Bookmark with useful list of technical abbreviations

## The Catalogue you MUST have!

Details of our popular Credit Account Service and our Easy Ordering System are included in the catalogue.

**Only 55p.**  
plus 20p POST AND PACKING

**POST THIS COUPON**  
with cheque or P.O. for 75p.

Name \_\_\_\_\_

Address \_\_\_\_\_

\_\_\_\_\_

**HOME RADIO (COMPONENTS) LTD., Dept. SW,**  
234-240 London Road, Mitcham, Surrey CR4 3HD.

The price of 75p applies only to catalogues purchased by customers in the UK and to BFPO addresses.

Regd. No. 912966 Lon.

# KW

ELECTRONICS  
LIMITED

## Improve your DX results with KW equipment of quality

# beat VAT- buy now!

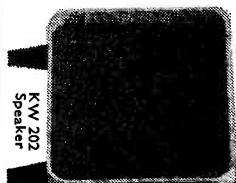

KW 202  
Speaker

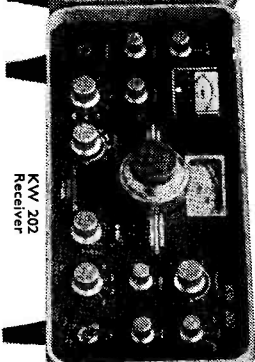

KW 202  
Receiver

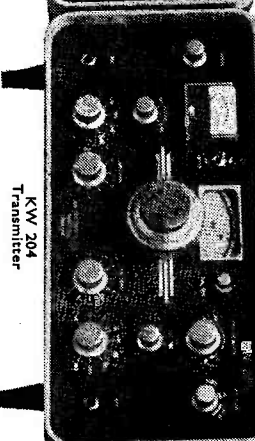

KW 204  
Transmitter



KW 107 Antenna  
Tuning System

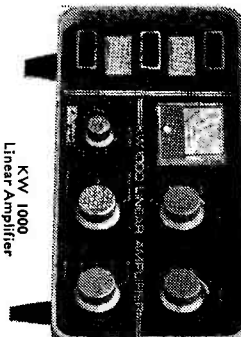

KW 1000  
Linear Amplifier

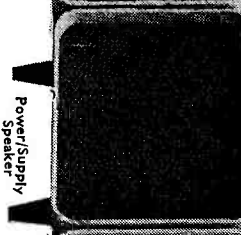

Power/Supply  
Speaker

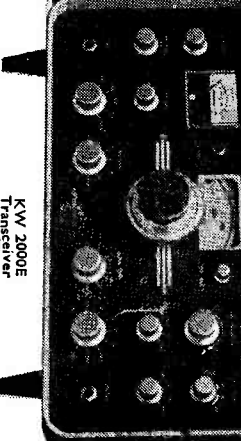

KW 2000E  
Transceiver

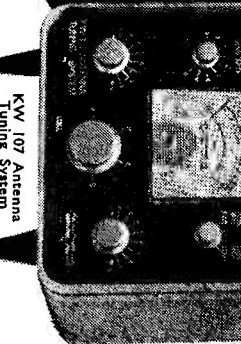

KW 107 Antenna  
Tuning System

**K. W. ELECTRONICS LIMITED**  
1 Heath Street, Dartford, Kent  
Telephone : Dartford 25574  
Cables : Kaydublew Dartford

All equipment is available through our UK agents : The Amateur Radio Shop—Huddersfield ; Chas Young Ltd.—Birmingham ; Derwent Radio—Scarborough ; R T & I—London, E.11 ; Stephens-James Ltd.—Liverpool ; Radio Shack—London, N.W.6 ; L. Hardie—Aberdeen ; Amateur Electronics—Birmingham ; Western Electronics—Southampton ; J. and A. Tweedy—Chesterfield ; Reg Ward & Co. Ltd.—Axminster ; John MacMahon Ltd.—Enniskillen ; Patrick McGorman—Clones, Eire ; Saltash Radio & TV—Saltash, Cwll ; CQ Electronics—Warrington ; or from accredited agents overseas.

# KW

ELECTRONICS  
LIMITED

EASY TERMS ON EQUIPMENT AVAILABLE OVER 12, 18 OR 24 MONTHS

★ ★ ★ ★ ★ ★ ★ ★ ★ ★  
 ★ **CUSTOM** ★  
 ★ **BUILT** ★  
 ★ **TO** ★  
 ★ **FIT YOUR SHACK** ★  
 ★ **AND YOUR POCKET!** ★  
 ★ ★ ★ ★ ★ ★ ★ ★ ★ ★

The Space Age WORLD RECORD award winning 7' 6" long All Band JOYSTICK VFA Antenna—JOYMATCH A.T.U.—TRIO RECEIVER or TRANSCIEVER—Matching HEADPHONES—A COMPLETE STATION IN ONE COMPACT PACKAGE—THE FLAT DWELLER'S DREAM!

★ 1972 JOYSTICK VFA £11.40 (A); JOYMATCH ATU 111 or 111A £11.40 (B); JOYMATCH ATU LO-Z500 £16.45 (C).

### COMMUNICATIONS HEADPHONES £2.60 (D)

(All including postage, packing, accessories and insurance.)

**PARTRIDGE PACKAGE No. 1**  
 9R59DS receiver ... £49.50  
 \*Items (A); (B); (D) above £11.00  
 Complete Gen. Coverage Station ... £60.50

**PARTRIDGE PACKAGE No. 2**  
 IR310 receiver... £75.00  
 \*Items (A); (B); (D) above £7.00  
 Complete Amateur RX Station ... £82.00

**PARTRIDGE PACKAGE No. 3**  
 JR599 receiver... £185.00  
 \*Items (A); (B); (D) above FREE  
 Complete Amateur RX Station ... £185.00

**PARTRIDGE PACKAGE No. 4**  
 TS/P5515 Transceiver  
 180V ... £210.00  
 \*Items (A); (C); (D) above FREE  
 Complete TX-RX Station ... £210.00

### BARCLAYCARD — ACCESS — PERSONAL LOANS !!

ALSO: SP5D SPKR. £4.50: OA2 MAINS STABILISER 67p.

**NEW:** World-wide reception on the amazing "DX—CRYSTAL SET" £1.75 (+ 25p) including unique aerial.

### PARTRIDGE BUDGET LINE—

**ARTIFICIAL EARTH—SOLVES YOUR EARTH PROBLEMS £4.80: AERIAL BANDSWITCH—TUNED AERIAL £4.80: A.T.U. KIT—FULL COVERAGE TX/RECEIVER £4.80: ASSEMBLED £5.80.**

(All including Postage, Packing, Accessories and Insurance.)  
 Send 3p stamp for full illustrated details of Partridge Products.

TRIO brochures (state which) 3p stamp extra.

**ADD V.A.T. TO ALL QUOTES FROM APRIL 1st**  
 CARRIAGE AND INSURANCE EXTRA OVERSEAS

BOX 4,

**PARTRIDGE**  
 BRADSTAIRS KENT ENGLAND  
**ELECTRONIC** Ltd

Phone: 0843 62535 or 62839 cheap periods.

Due to Warehouse Clearance we have a few low powered F.M. VHF Wireless Station Type A, A.F.V. No. 88. Contained in two units (1) Transmitter/Receiver, (2) 12 volt Power Unit and L.F. Amplifier. The Tx and Rx are contained in a waterproof diecast alloy case, using a total of 14 valves, operates on four switched channels which are Crystal controlled.

All 8 Crystals are supplied, and are the same in each set. Therefore all sets will transmit and receive to each other, provided each are switched to the same channel out of the four.

The Stations are supplied with mounting carriers, 2 vertical whip aerials, plus aerial base, spare valves, bulbs, mounting screws, connectors, etc. Including the operating manual giving all details, plus circuits of the wireless set.

All above items are individually boxed and wrapped, placed in original transit case.

**ABSOLUTELY BRAND NEW—**Made by Echo for the Government no expense spared, few only available at £9.50, carr. £2.

### RADIO TELETYPE TERMINAL SET

A. type, AN/SGGIA latest Government release of these sought after units, housed in metal case, approx. size: 8" x 19" x 16" deep. Using a total of 11 valves, supply voltage: 115 volts 50 c/s. Containing Meter switched for checking, send and receive bias, send and receive level loop and plate current, in fair used ex-Government condition. Few only available at £7.50, carr. £1.50.

### FREQUENCY SHIFT CONVERTER AND COMPARATOR

Type AN/URA-8B for diversity use or single channels, £15 and £10 respectively, carr. £1.50 and £2.50.

### FREQUENCY METER TS186 D/UP

Recent Ministry release of this scarce and valued unit, this is basically the VHF/UHF version of the BC221. Range 100 mgs. to 10,000 mgs.

Distributed over approx. 16,500 dial divisions, each meter (same as the BC221) contains its own book of calibration charts, plus circuit and instruction book. Contained in metal shockproof transit case, with supply cable, supply 115 volts  $\pm$  10% 50 c/s. Output on headphones or meter in the front panel. Accuracy is 0.01%, 0.002% on the crystal calibrator check points. Sensitivity for R/F signal input 500 micro volts to 1 volt. A plug is also provided for Video output for connection to an oscilloscope, RF input connection is via coaxial cable or standard wave guide. Limited number available, £18.50, carr. £1.50.

**LARGE QUANTITY OF TELEPRINTER PAPER**  
 Available, sprocket fed, contained in sealed packs, each pack containing 4 separate wads, price 60p per pack of four pads, post 25p, or wooden crate containing 5 packs equals 20 wads, £2, carr. 50p.

**CREED TELEPRINTER MOTORS** for mains 200/250v. A.C. for use on 7B teleprinters, etc., available brand new, £2, post 25p.

**MALLORY LONG LIFE BATTERIES.** Type RM12, 1.35 volts as used in contamination meters No. 1, £1 per box of 50, post 25p. Brand new ex-Government. Terms: C.W.O. or uncrossed P.O.'s in case stocks run out, so we can refund same.

## JOHNS RADIO

424 BRADFORD ROAD,  
 BATLEY, YORKS.

Phone: BATLEY 7732



ADVERTISERS INDEX

	Page
Aero & General Supplies ...	57
A.H. Supplies ... ..	54
Amateur Electronics (G3FIK)	9
B.I.E.T. ... ..	57
The Amateur Radio Shop (Huddersfield) ... ..	59
J. Birkett ... ..	61
British National Radio School	59
Canley Engineering ... ..	57
I. N. Cline ... ..	58
Colomor Electronics ... ..	53
Derwent Radio ... ..	54
Dept. of Electrical Engineer- ing, Loughborough ... ..	51
E. & E. Services ... ..	60
Echelford Communications	12
Eddystone Agents ... ..	60
Fley Electronics ... ..	58
Ensign Electronics ... ..	58
G3HSC ... ..	56
G.W.M. Radio ... ..	61
Hamgear Electronics ... ..	7
Heath (Gloucester) Ltd. ...	3
Holdings Photo Audio Centre (Trio) ... ..	60
Home Radio (Comp.) Ltd.	12
Imhofs ... ..	59
Johns Radio ... ..	14
K. W. Electronics ... ..	13
K. W. Developments, Ltd.	6
Low Electronics <i>inside front cover</i> , 1	1
Markham Electronics ... ..	61
S. May (Leicester) Ltd. ...	6
Mosley Electronics ... ..	8
Gerald Myers ... ..	57
North West Electrics ... ..	11
P. & P. Developments <i>back cover</i>	<i>back cover</i>
Partridge Electronics Ltd.	14
Radio Shack Ltd. ... ..	7, 16
R. T. & I. Electronics Ltd.	8
Scientific & Tech. ... ..	10
Senator Crystals ... ..	6
Small Advertisements ... ..	51-56
Solid State Modules ... ..	10
Spacemark ... ..	61
SSB Products ... ..	58
Stephens-James ... ..	2
Strumech Engineering ... ..	59
Studio Electronics ... ..	16
S.W.M. Publications <i>inside back cover, back cover</i> , 2, 51, 55, 57, 62, 63, 64	<i>inside back cover, back cover</i> , 2, 51, 55, 57, 62, 63, 64
Taurus Electrical Services	60
J. & A. Tweedy ... ..	55
Reg Ward & Co. Ltd. ... ..	58
Waters Electronics ... ..	16
Western Electronics Ltd. ...	4, 5
Chas. H. Young Ltd. ... ..	53

# SHORT WAVE MAGAZINE

(GB3SWM)

Vol. XXXI

MARCH, 1973

No. 353

CONTENTS

	Page
<b>Editorial—Items of Interest</b> ... ..	17
<b>Communication and DX News</b> , by E. P. Essery, G3KFE ... ..	18
<b>Adaptable 30-Watt Transmitter, Part II</b> , by F. G. Rayer, A.I.E.R.E., G3OGR ... ..	24
<b>Two Aerial Ideas</b> ... ..	26
<b>Aerial Current Meter</b> , by C. J. Davis, G3VMU ... ..	27
<b>Coax Adapter Device</b> , by D. E. Knowles, G3UVA ... ..	28
<b>Sideband Transverter for Two Metres, Part I</b> , by J. D. V. Ludlow, GW3ZTH & C. J. Dunbar, GW8EHK ... ..	29
<b>The Mobile Scene</b> ... ..	34
<b>Solo Mobile Expeditions</b> ... ..	34
<b>Specially on The Air</b> ... ..	34
<b>VHF Bands</b> , by A. H. Dormer, G3DAH ... ..	35
<b>The Month with The Clubs—From Reports</b> ... ..	40
<b>“SWL”—Listener Feature</b> ... ..	45
<b>New QTH's</b> ... ..	50

*Managing Editor:* AUSTIN FORSYTH, O.B.E. (G6FO/G3SWM)

*Advertising:* Maria Greenwood

*Published at 55 Victoria Street, London, SW1H-0HF, on the last Friday of the month, dated the month following. Telephone: 01-222 5341 & 5342*

**Annual Subscription:** Home: £2.75 (£3.00 first class) post paid  
Overseas: £2.75 (\$7.00 U.S.), post free surface mail

**Editorial Address:** Short Wave Magazine, BUCKINGHAM, MK18 1RQ, England

AUTHORS' MSS

*Articles submitted for Editorial consideration must be typed double-spaced with wide margins on one side only of quarto or foolscap sheets. Photographs should be lightly identified in pencil on the back with details on a separate sheet. All drawings and diagrams should also be shown separately, and tables of values prepared in accordance with our normal setting convention—see any issue. Payment is made for all material used, and it is a condition of acceptance that full copyright passes to the Short Wave Magazine, Ltd., on publication.*

© Short Wave Magazine Ltd.

## LISTEN TO THE WORLD WITH THE XCR-30 MARK 2 BARLOW-WADLEY'S UNIQUE CRYSTAL-CONTROLLED RECEIVER.

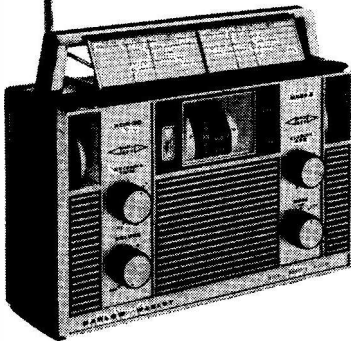

A COMPLETELY NEW CONCEPT IN PORTABLE RADIO DESIGN

1. 0.5 to 30 MHz continuous coverage—direct readout.
2. Antenna tuning for maximum sensitivity.
3. AM, CW, SSB (selectable USB and LSB).
4. Self powered by six SP2 batteries.
5. Power jack for external 6–12v. D.C. supply.
6. Headphone jack
7. Drift free reception.

£89.50

Sole Distributors :

### RADIO SHACK LTD.

Open 6 days 9 a.m. until 5 p.m.

Closed for lunch 1 p.m. until 2 p.m.

188 BROADHURST GARDENS  
LONDON, NW6 3AY

Just around the corner from West Hampstead Underground Station

Telephone : 01-624 7174 Cables : Radio Shack, London, N.W.6.  
Giro Account No.: 588 7151 Access and Barclay cards accepted

### SPECIALISED KITS

**HIGH STANDARD** Low Frequency Source (to article by J. M. Osborne, Wireless World, Jan., 1973). Reference accurate to 2 parts in  $10^{11}$ ! A Phase-Locked Loop designer approved kit to professional standards with glass fibre p.c. board and all components including hardware, case, etc. Full constructional details from the designer are included. Probably the most economic high precision signal source available. Kit **£22.25**

Extra for built and tested only ... **£6.55**

High frequency version being developed.

### FOR FM STEREO ENTHUSIASTS

The best decoder we know—The Motorola Phase-Locked Loop. No coils to align. Just one pot. to set, and no instruments needed for this.

Complete kit ... **£3.40** Built and tested ... **£5.40**

Version with p.s.u. facilities, on plug-in card for any positive rail of 12v. or more (specify).

Kit ... **£5.20** Built and tested ... **£7.30**

Version with integral power supply for 240v. A.C. input.

Kit ... **£7.50** Built and tested ... **£9.70**

**PLEASE NOTE**—We are prepared to consider offering kits for any published article—send details for quotation. Our service is unique; ALL communications are acknowledged by return!

### CLEARANCE CORNER

Send for lists—large s.a.e. please!

R1155A receivers, some spares and data ... ea. **£9.00**

One only RF24 at ... **£2.50**

R1475, ex RAF, 2-20 MHz receivers, many possibilities at ea **£11.00**

Standard cassette recorder with R/C mic. ... **£13.00**

Please add 75p as part carriage.

Enquiries welcomed, Trade supplied. Order now for early delivery.

### STUDIO ELECTRONICS (G8AIP)

7 COPPICE HATCH, HARLOW, ESSEX

Tel. Harlow 25457

Regret callers strictly by prior appointment at present

## MINIATURE BEAMS AND VERTICALS

Don't wait for spring. VAT will be too late!

Mini-Products beams and verticals are already in use by many U.K. stations. Never before have such compact beams been available to the European amateur. No garden is too small. Now every amateur and short wave listener has the opportunity of erecting a beam for the high frequency bands. These beams are really robustly made and yet are so light that they require no more in the way of support or rotation than a vhf array. Look at the specification below and then drop us an S.A.E. for full details and performance data including SWR curves.

10–15–20 metre operation

No traps to burn out

Unique end loading for maximum efficiency

Extremely good bandwidth

1500 watts power rating

11ft. element length

6ft. turning radius

G2KF says—"My HQ-1 Mini-Products antenna is proving to be very satisfactory and was not affected in any way by a recent gale."

★ Treat yourself to a pair of 1.5 kW Wightraps and make yourself a 5 band dipole. At **£3.35** per pair (20p) including full instructions you won't get them any cheaper.

Mini-Products sole European Distributors.—

### WATERS ELECTRONICS (G30JV)

8, GAY BOWERS, HOCKLEY, ESSEX.

Callers by appointment

Evenings Tel. 4930

# The SHORT-WAVE Magazine

## EDITORIAL

### ITEMS OF INTEREST

**Walkie-Talkie Warning:** We are informed by the Ministry that the imported Zodiac walkie-talkies—now being extensively advertised—would not be licensed for use by a private individual and that they would require modification (as to frequency) to make them suitable for operation in our 10-metre band by a licensed amateur. We understand that the advertisers concerned have been notified of this ruling by MinPosTel.

\* \* \*

**UHF Hazard:** Several readers have queried our comment in the January issue Editorial regarding the regulations for the new centimetre-band at 24,000 MHz. The dangers are very real. The health hazard due to UHF radiation by direct exposure depends upon its intensity, *i.e.* power used and proximity, and can vary from mild skin irritation to blindness or severe damage to internal organs. It is a well-known hazard against which the proper precautions must be taken—hence the Ministry's ruling.

\* \* \*

**RAIBC Membership:** The latest listings, dated December '72, show that the Radio Amateur Invalid & Bedfast Club now has a total of 421 members, of whom 165 are licensed amateurs and 256 are SWL's. They fall into various categories: Blind (76 Tx and 75 SWL); Permanent Invalid (84 Tx and 172 SWL) and others incapacitated in various ways, 14. This large family is in the devoted care of Frances Woolley, G3LWY, and her husband John Woolley, G3ESR. The object of their exercise is not so much charity (though a good deal of that is necessarily involved) but therapy, in the sense of helping members to enjoy Amateur Radio and thereby have a

positive interest in life—which is so very important for the blind or incapacitated.

\* \* \*

**VAT Exemption:** The fees charged to candidates for the R.A.E. and Post Office Morse Test are exempt from VAT—so says a letter from the Radio Regulatory Division of the Ministry. We are glad to hear it!

\* \* \*

**Index:** Each copy of this issue should contain, as a free loose supplement, the Index to the Volume just concluded. We now embark on Vol. XXXI—it cannot be said that we don't keep at it!

\* \* \*

**Photographs:** In a twelvemonth we are offered a great many pictures "for possible publication"—the pity of it is that they are about 50% unusable, either because the quality is too poor to justify the expense of making a block, the subject is badly posed, the accompanying notes are insufficient, or instead of black-and-white prints of about postcard size, we are sent negatives clipped from narrow film strip, involving additional processing (very seldom justified). We pay for all photographs we use—and we need a good many for each issue. But there is no use offering prints that are not clear and sharp—or, in the case of groups and Club pictures, with half the company having their backs to the camera, or with one large bald head in the foreground—or the back of the print covered with a smeary ball-point pen scribble (*all* the notes should be on a *separate* sheet, with no ambiguity in the way callsigns are written). Pictures worth using must be of reasonable quality with (in the case of groups) faces turned towards the camera and correctly identified by callsign.

Austin Forsyth  
G6FO

# COMMUNICATION and DX NEWS

*E. P. Essery, G3KFE*

THIS is perhaps as good a time as any to suggest that some of the local nets being taken on Two could well be transferred to Ten—a lovely band for ground-wave working—where simple aerials such as dipoles in the loft will suffice for both local matters and the odd DX contact on those occasions when the band does blossom out—and, you know, even at sunspot *minima*, Ten is likely to attract all the usual VHF-type forms of anomalous propagation, which give cover of much of Europe and N-S DX. Ten is not often as dead as many people suppose, but rather suffers from lack of real activity. What about coming on and giving a shout of CQ, at least once a week, day or evening, on around, say, 28.3 MHz, and just seeing what the result turns out to be—let us know what you work for the May piece, to give time for a bit of exploration.

G3NOF (Yeovil) reports little on the band, and when it was open, an S9 signal was liable to disappear as suddenly as though the aerial had fallen down. Mornings provided the odd African, if anything, and occasionally in the afternoon would creep in a weak-and-watery W—the only SSB contact was with RA6JAZ.

All is not lost, though, says G3USF (Keele), although even he is prepared to admit conditions are markedly poorer than they were, say, a year ago. G3USF heard the 3B8MS beacon, now on its permanent frequency of 28190 kHz almost every day, but the lifts have been both relatively brief and geographically limited—which is not to say they weren't useful to someone lying in wait. The usefulness of these lifts can be gauged from a list comprising (SSB) A2CEW, CR4BS, CR6AG, CR7AF, VR7CZ, CX1BB, CX6AM, ET3FF, ET3USE, SV1BV, ZC4DS, ZC4TE, ZE1AS, ZE1AV, TJ1JJ, TU2DD, ZD9BM, ZS6AD, ZS6CJ, 4Z4ME, 3B8DG, 3B8CV, 7Q7RF, the perennial 9J2DT, *plus* occasional W's and Russians. Beaconry is, of course, the way to

assess conditions on this band, and apart from 3B8MS, there are VE3TEN, Ottawa, on 28175 kHz since January 2, and the ZC4CY beacon which should be operational in the very near future.

GW4BLE (Monmouth) has had the long-awaited visit from the Post Office—results, one hi-fi equipment back to the retailer for modification, one TV set back to the shop, four TV set owners given a month to correct faults in the sets themselves (and/or the TV aerials) until the completion of which by the TV viewers the GPO won't take any further action. GW4BLE has been given the go-ahead to operate after the month is up, regardless of whether the viewers have cleared their own problems. This shows the very fair and impartial attitude now being taken by the Radio Interference Dept.

On Ten, most days have seen the morning openings, East-West, plus the odd African at low strength. The first day of the ARRL DX Test produced W4's around tea-time, and a momentary appearance of VO1CU who was at a meter-S7 and then just dropped out in a few minutes.

G3VLX (Chislehurst) had a little dabble, which yielded CR7IZ, 9J2AY, ST2SA, 4W1BC and VP2LI, all on SSB.

The numbers of that group we described a couple of issues back as the "pirates of Penzance" seem to increase each month! Junior op. —sorry, Paul!—G4BKI reports only locals worked on Ten. But, on turning over the page we find another member of the group, this time Dad, G3DLH, on behalf of G4AMJ who had been despatched to school. Three of them in one household—it must be bedlam when they are all on Ten together!

## Now Fifteen

G3FYR (Petts Wood) writes in another connection, and remarks that he has gone "with-it and really modern!" There is an FT-101,

feeding through an E-Zee Match, K.W. Power Meter and SWR indicator, to an 8KW trap dipole. This has duplicated guy-lines, one kept slack, so that should a guy break, the reserve can immediately be tensioned up to take the strain—a good idea. During the November openings, a VK in Melbourne was working lots of U.K. stations on SSB with just a five-foot whip—a pity he chose to do so before G3FYR had mastered the art of driving his new machinery. However, such a getaway is wonderfully encouraging, and contacts have since been made on Fifteen with W6MSM, W6QC and W6SO to prove it all works OK.

How nice to hear again from G3VLX (Chislehurst), writing in the main about an SWL of our mutual acquaintance. Deryck still has the FL-200B/FR-100B combination, now backed up by a TA-33Jr. on a tower at 40ft., heaved up by volunteer muscle-power. We imagine the volunteers were "amused" when, having got it all up, it was found that someone had connected the balun incorrectly! However, the average report *has* gone up a little, as given in QSO's on SSB with 9H3WPD, EL9C, VP2LI, VK6HE and A4FD.

Fifteen for G3ZPF (Dudley) meant quite a few contacts, among them VK3LM, OX3SL (who has now got SS/TV gear going), 9Y4EH, YV3BJ VP2VAM, VP1BH, 9J2HE, 9J2AY and, for a change from SSB, KP4USN on CW.

By the time G3NOF is ready to go to work at 0830, Fifteen has usually not shown signs of opening, but it is known that the JA/VK/ZL path has been giving around 0900, albeit signals have not been strong. A few short-path stations from S.E. Asia were heard around 1100, but little in the way of Africans appeared. QSO's were registered with VU2GJ, VU2TVA and some W's.

At this point G3RFG comes in with his usual long list; Stan has an even longer one on Fifteen because

this month he seems to have given Ten a miss. We notice CW contacts with HK2DP, K2QIL, K3USC, VE3AKW, VE3CTE, WN1QPC, W2WQ, WB2OZW, W3GFB, W3NBY, WA3PXA, WA3CSR, W4KN, WB5BLF, W6UA, W8JKM, W9BR, WB9IJL and ZFISE.

Quite a shoal of stations fell into the clutches of G4BKI; CW accounted for Stateside stuff and 9L1MF, while the SSB attended to YN1URI, ZE8ZW, 9K2BQ, SV1FT, 5N2ABG, VU25MX, VQ9HCS, ZD8TS, HR3AC, EL7C, A4FD, SV0WU, VP2DH, EA8FH, VQ9R and ZD3D.

For G3VLX came this last-minute burst of activity: Fifteen gave CIIADV on Prince Edward Is. and YV3VU, who was using *two kilowatts* to get his S9 report!

For GW4BLE we see SSB contacts all the way, with EL8G, FY7AE, EL9C, WB2JGD/KP4, 9G1FF, 5H3MT, LU7AJF, PZ1DR, ZB2CO, SV1GP, LU1DAB and 9J2DT.

### Twenty

Has its moments. One of the nicest was when your conductor chipped into the Commonwealth Net—there was a UK2 who thought he was part of the British Commonwealth, and before that one was sorted out VK2AJH/P/VP9 popped up, which confused the issue still further.

The short spell G3FYR had on 20m. up to the time of his letter showed him working SSB with VK7CH, ZL3JC and JH6ALF on the trap aerial.

G3ZPF reckoned conditions were none too great, but he persevered, and came out of the fray with VP9GO, VQ9DC, CN8CE, VK6MK, VQ9HCS, JY9VO, YV0AA, VQ9MI, EP2DO, ET3USC, OD5GU, OD5FM and W1-2-3-9.

G3UZ (Goring, Sussex) does not believe in early rising nor yet in staying up late, so returned to his old love, CW with a Swan 350 at 150 watts to a dipole; George finds the call signs came back better on the key—don't we all! He shows CW log entries against FM7WG, EA8IQ, JY1FOC, UA9AAC, UA9APP, UA9CMB, UA9HAD, UJ8AR, UL7GAA, UK0AAC, UK7JAA, VK2CX, VK3VC, VE2BAG, VE3UE, VU2IN, ZM2AJ, PY7VOU, VO1EV, plus numerous



DJ6NI is Gunter von der Ley, D-4320, Hattingen-Ruhr, Raabestrasse 42A, West Germany. His line of gear is Trio TX-599, FL-2500 and JR-599, into a two-element Quad for 20 metres. And he has a Morse key as well as the microphone.

W's and, of course, tons of Europeans. On a different point, George rubs home the necessity for correct addressing, when he mentions that a letter accidentally addressed to "Short Wave Magazine, Buckinghamshire" came back "not known." Yes, it's a big shire! (The Post Office do usually find us but this would be a bit much for a main London sorting office!)

Apart from spending three mornings working traffic after the Managua quake, W6AM (Long Beach) seems to have given Twenty SSB a good old pasting, with VQ9R, 9K2AU, W6GLC (who had 7Z3AB in the shack), ST2SA, 4W1BC, A4FD, OD5TM and OD5HE, 9N1MM, YV0AA (worked from Aves Is. on 7-14-21-28 CW and SSB), ET3USA, EP2FB, and A2CCU.

For G3RFG, CW yielded pleasurable contacts with CT2BO, JA8ARA, JH1GRC, K2MH, LU9FAN, UA9LAC, VE3JE, VK3AWP, W2WY, WA2BEB, W7ULC, W8GE, W8PBO, WB8AUH, W9BR and ZL2ASJ.

Around 0800-0830 has been "opening time" on Twenty, says G3NOF, starting with JA's followed quickly by VK and ZL's over the long path, although again signals have not been very strong; in the evenings, conditions to West Coast W and VE have not been much good, and the Africans too have been patchy.

Normally, by 1900 things have closed although there was the odd evening when the band stayed open till midnight, either to the States or just to Europe. G3NOF on SSB was heard by EA6BG, HK3CMH, HK3CUT, HR3AC, JA4ATU, K7RSC, KC4UST (McMurdo Bay), M1C, PZ2AB, VE7AAD, VP2KH, VK's, ZD3M, ZD7SD, ZS's, 5T5CJ, 5U7AZ, 6W8AL, 8R1UGF, 9H4K, 9H5D, 9J2TC, 9L1VW and 9Y4PH.

G2HKU (Sheppey) has continued his regular morning sessions with ZL1FB, ZL1VN, ZL3RS and ZL3SE.

Twenty for G4BKI was not a great attraction, Paul obviously having a preference for Fifteen; but he did tangle with CT3AS, ZL4FR, 9Y4BH and CR7IZ, all SSB.

### Piracy

One thought there were limits to everything, even the activities of pirates—but here we have a case of a pirate who will not be satisfied even with using a phoney call, but has to purloin a YL's—G3ZZZ (Hassocks) is the sufferer; José says she is being pirated on Top Band CW, for which she has no facilities. As a result, she is being snowed under with QSL requests. Any "G3ZZZ" appearing on Top Band is quite definitely a phoney—so tell him just what you think!

Another sufferer is G3EPU

(Wimbledon) who has not been on for a couple of years now; and when he was, it was mainly 160m. or 2m. phone. Ken is getting QSL's from all over the place, CW, AM and SSB, all bands, for contacts going back as far as 1966!

### Here and There

Referring back to our note about HV3SJ last month, your conductor has since had a telephone chat with G3WET, just come back from Rome, where he spoke to Brother Ed. It in fact now appears that there is no intention to put HV3SJ off the air; all that has happened is that no more funds will be forthcoming for maintenance of the rig. Under the cir-

### BRIEF DX DATA

Call	Details
VR1AA	Dan is on Twenty SSB, can QSY to 7084 kHz at 0600, and to 3785-3800 at 0630 before QRT 0700z.
XF4	Revilla Gigedo Is. Mar. 15-21, XE1IHK and others hope to be operational from Benito Juarez Island, and to have a special prefix for the ARRL DX Contest—6F, 6G, or 6J.
XUIAA	Tony has now completed the QSL chore, and the last few cards are being despatched. Anyone still short, write with details to Tony Kathro, 10 Erw Wen, Rhiwbina, Cardiff, Glam., South Wales.
JD1ACF	Ogasawara Is. Try 14170 kHz SSB around 0900. QSL via JA1AOF.
IS1A	Spratly. The operation has been postponed due to recent political events affecting the operator availability. It may have been operational, nevertheless, by the time this is in print.
KA1CQ	Iwo-Jima, Mar. 20-27, with emphasis on 40-80-160m., and will be on all bands in the Contest. Look around frequencies 1900, 3537, 7080-7090, 14220, 21270 and 28520 kHz.
4K1	This prefix is being used by Antarctic U.S.S.R. stations, 1/1/73 effective.

## Reporting the HF Bands

cumstances, if anyone who has had QSO's with this friendly character (and hence worked a new country in the process) would like to offer a donation, large or small, towards the repairs required in the station, they should send their offering to G3WET, QTHR, who will do the necessary. It is, we understand, the case that U.S. amateurs will be doing something similar to the same end. (It could end up that the Vatican has more money for HV3SJ than it knows what to do with! These situations always work in extremes!)

WB2OZW (New Jersey) has a long and thoughtful letter on the subject of the relative signal strengths in the CW and SSB ends of the bands. Paul finds the general run of CW signals levels much lower, and when a Sidebander does turn to CW he stands out head-and-shoulders above the others. As Paul says, the name of the game is "Communication" and there is much scope for the chaps with QRP and "catch as catch can" aerials to improve their signal at the distant end, without compromising any principles dearly held. Reading between the lines, WB2OZW likes to ragchew, on CW or SSB, but many times finds it all but impossible to complete a QSO with the weaker U.K. stations because of the heavy local band occupancy *over there*—we tend to forget in our delight at putting 10 watts into the U.S. that the poor chap at the other end has to copy through QRM that can be stronger even than the Red Army Choir—the least we can do with our QRP is to radiate it efficiently.

G4ABS (Westgate-on-Sea) may have a new callsign, but he has been an SWL for 22 years and so knows the form pretty well. His particular moan is the state of the band on Eighty—not the DX Net question again, but the general phone section. He puts out a CQ, and when he goes over, this is what he hears: A German or two, possibly a Frenchman, a PA, maybe a Norwegian, all calling each other, a lonely cow (Aaaaah!) a blackbird and a canary,

a 'printer, a bit of chirpy CW, and finally under it all, a little weak signal calling *him*—which he cannot possibly copy through the noise! No doubt about it, Eighty has got much worse of late years. Maybe kindly MinPosTel would listen a bit more and give a few of them the chop, which would improve things no end. There is plenty of justification for drastic action, when one listens to much of what goes on—bad language, blasphemy and generally appalling behaviour in the operating sense outside the terms of the licence.

### Forty Metres

This seems to be the band on which slow-scan television (SS/TV) goes on. Our earlier assumption (because of misleading information) that the Ministry automatically allows SS/TV transmission was wrong—the licence does *not* permit slow-scan television transmission on any amateur band without prior permission. The operating conditions (which are complicated) will then be laid down by MinPosTel. There will be no difficulty about this provided prior application is made and, for U.K. stations wishing to transmit SS/TV, the technical requirements are accepted and can be met.

SS/TV is at the present time such an esoteric exercise that we would doubt that more than a very few U.K. amateurs are interested in SS/TV transmission—the expense, the bother and all you get is a smudgy face or a blurred callsign, sideways on a mottled screen.

The theme of SS/TV has been plugged for at least the last ten years—the keen and capable types have produced remarkable results in the DX sense, but still no more than blurred callsigns on a smudgy screen. (*Editor*).

G3RFG paddles his key on all the bands which he reckons to be usable, and this month found *Forty* to give K2UZO, K3RDF, K4VE, PY7AWE, VK3MR, VEIBX and 8P6BU. On an entirely different tack, Stan worked W7WN, aged

67; W2WY, aged 77; and W5BSR who is 83—so who is the *oldest* active amateur in the world? It could, one thinks, possibly be a prize for the Russians, where there is one part of that vast country which seems to bestow enormous longevity on its inhabitants. However, any offers for the oldest active amateur?

Only one 7 MHz contact as such appears in the W6AM list, on CW with PZ1AH, although we do know he worked the Aves Is. expedition on both Phone and CW.

Old Timer G5ZN has retired to Withersea, Yorkshire, where he looks out on to the sea and the winds; and where he can once again take up his favourite activity of bashing the key on Forty—old pals please to keep an ear open for Philip.

G2HKU has some very rude things to say about the BC stations intruding into Forty—we agree!—but still takes the odd little peek at things, and came away with CW bookings to PY7CD and PY7BJM, plus SSB to PZ1CU. Ted reckons things were much more fun when he was on DC mains, and there was no such things as beams for Top Band, Eighty, or Forty; nowadays, he reckons, the cheque-book is the dictator for DX success. Well, Yes and No.

### Eighty

More reports on this band, for a change! G3RFG (Henlow) used CW as usual, and made it across to K3NPV, W1TM, WB2BGK, W3VA, WA3JYB, W5MCO, W8UM, WB8IJW and W9AC.

G4BK1 gave the band a going-over, and emerged with SSB contacts with M1I, EA6BG, ST2SA, OH0MA, CT2BG and 7X2MD—considered as worth a mention.

At GW4BLE, the contacts on Eighty included C11UA (VE1UA with a special call), CT2BG, OH0MA, KV4AM, YV6AMW, VO2GD, ZB2CO, ZB2CF, ZL3KK/C (Chatham Is.), ZL4HJ, ZL4KF, PY4BTK, W1, W2, W3, W4, VE1, VE2 and VE3, despite restriction of operating to mornings before work on Eighty and weekends on the other bands. Nonetheless, GW4BLE is now up to 155 countries accounted for since he got his ticket, with the cards coming



For the Cornish Amateur Radio Club activity on the occasion of the Marconi 70th anniversary, Cape Cod-Poldhu, at the Cornwall end they ran Heathkit HW-100 and Yaesu FT-200, the operators shown here being G3UCQ, G3XFL and G2DUP.

in nicely, more than 50 of the total countries now being confirmed.

The next list set your poor old conductor's head buzzing! G3ZPW (Wombourne) runs a TS-510 into a linear amplifier at 350 watts, fed to a ZL Special at 47 feet, which went into operation on January 6, after trials with phased verticals, delta loops, two-element Yagis and so on. The list covers the 24 days after putting up this aerial, and runs to a total of *fifteen* pages of standard log sheets! One notes operating hours of, roughly, 2130, through midnight to 0230-0300, with the DX seeming to improve as the night wears on. Europeans are here aplenty, plus most of America, lots of Caribbeans, VP2, 6Y5, 8P6, KV4, KP4, and so on repeating time and time again, PJ2, YV's, ZB2's, ZL's, VP7, XE, EP2TW, ZF, an "MP4BFR" on whom some doubt is cast in the log, PZ, HK0, TI2, KZ5, and HP1JS. Looking at these pages of the log, one notes for much of the time the G3ZPW inputs at the 120, 150 or 180 watt level, and still getting S9 reports, the linear being put on only when the going seemed tough. The aerial main beam direction shown in the

drawings is as near as makes no odds due West. It just goes to show what the DX exponents of Eighty can do, if they have the facilities to put up a decent aerial. Much of this stuff would have been workable on a properly arranged vertical, by someone who had the inclination to sit up late. One hopes G3ZPW will give us some more insight into the DX on 3.5 MHz, he having the courage to brave the QRM.

By way of VK6HD and GW3YGH, we get it that VK6CT is on most evenings, between 2100 and 2200z, around 3512 kHz, looking especially for GW, GC, GD, on CW.

*Just a Footnote:* We do *not* want to see voluminous photostated log entries, from which we are expected to extract the plums. The contacts that matter to us for mention in this piece are those that the correspondent himself feels to be most interesting. (*Editor*).

### Now Top Band

Last month, at the time when he should have been posting his report, GM3YOR (Kirkcaldy) was in the midst of a Mountain Leadership course in the Cairngorms. However,

Drew did write, even though he missed the deadline, to add his final scores, and to mention his contacts with DL8PC, DK2QL, G3PKS, GM3BNX in Berwick, GW4BIF in Merioneth, shoals of OK/OL, and PAØRCH.

G3YMH (Staines) comes in from Cambridge University, with various matters of controversy. On the question from G2HKU about aerials, Ron has a 45ft. vertical, with a loading wire at the top running horizontally for 105 feet, to put the current antinode about 15ft. up the vertical section. For the earth side, there are copper stakes driven into the garden at 4ft. intervals, with a piece of 15 amp. copper wire brazed to the top of each one, right down to the end of the garden; all electrical joints are coated with grease and bound with tape to avoid corrosion and consequent noise. More radials are not found to be worth-while, as the site is on waterlogged soil near the Thames, and by the side of an artificial lake. G3YMH has found that there are two marked peaks across the Atlantic, one corresponding to dusk in the States and the other to dawn over here—for which the first opening needs a vertical for low-angle radiation, through at dawn here a higher angle of radiation does better. G3YMH goes on to mention his VK skeds, with VK3CZ; both sides have heard the other, but no complete QSO has yet resulted—all hearings corresponded to plus or minus 15 minutes of dawn in VK. VK3CZ also has heard G3TR, G3LIQ, G3IGW, G3YUV and has worked G3SZA and 4W1AE.

G3XAP (Stowmarket) is another one on the VK trail. Phil finds that while DX can be heard on a horizontal aerial, the stuff only started to be worked when he put up his vertical—60ft. high with sixty radials. Phil has had a “near miss”—he got reports both ways from a VK6 but just couldn’t copy the chap’s complete call. Phil emphasises his nine watts input—20 mA at 450 volts, and he has a SWL report from VK6, at least to convince him his signal was getting into VK6 receivers solidly enough.

G2HKU worked his CW with DL3MO, DLØRZ, OE5KE, and his SSB, as always, over to PAØPN. Ted is unhappy this month at the

number of stations to be heard operating in the Top Band “DX Window”—and who can blame him?

From Geoff Watts’ *DX News-Sheet*, we notice “Firsts” being knocked up, among them 5Z4KL, who worked JA7AO for one of them, and listens on Thursday evenings, 2030-2130 on 1802 kHz for EU and JA stations, reserving the weekends for the Americans. EP2BQ was another one to knock up a “First,” when he did the trick with ZL1BKX.

W1BB missed out on the best weekend of the season so far, and also the Aves Is. expedition, by way of a cruise in the Caribbean for a couple of weeks—nonetheless, Stew has so far worked 37 countries and 122 DX stations, as against 25/86 at the same stage last year. However, there are still problems with the DX-window concept over on their side of the Pond—the same difficulty as we have over here of chaps busting things up because they just don’t know the form, and don’t want to be told. He reports G3ZEM as having worked K6UA on December 10, the latter using two full-length verticals! An interesting little snippet is that Paul Godley, who started it all back in 1921 by hearing the first amateur signals from over the Atlantic from his GM site at Ardrossan, is still interested in Top Band, still listens around the bands and can still copy good

Morse at 40-45 w.p.m.

Yet another “First” comes up for mentions, this being the first GW/VK QSO on Top Band, done on January 7, by GW3YBH at 2110.

During the *CQ WW 160 Contest*, GW3YGH had aerial troubles, and so his only DX contact was EP2BQ, but he heard YV5CKR, PY1DVG, 5Z4KL, KP4AST and UB5WBN.

#### Culled from the Clip

The World Peace Day station, 9H3WPD, ran up a total of 1400 or so QSO’s, with some 140 countries, using KW-2000B and KW-1000 gear into a switchable ground-plane for the HF Bands and an 8KW trap dipole for 40 and 80 metres.

G2FWA has just completed a Heathkit HW-7, and is finding it a lot of fun working QRP CW, after six years during which Edgar succumbed to the lure of SSB. G8DV is another, local to G2FWA, who has built and is enjoying using one of these Heathkits.

G2NJ mentions the various QRP chaps he has worked during the month. There was André, ON4TA, worked eight times, with ON4TA’s input on occasion as low as 160 milliwatts. GW5TW ran 3 watts for two contacts, and then dropped it to 800 milliwatts for a three-way QSO involving G2NJ and G2CAS. G3KPT was worked, when the latter



“ . . . Our first eyeball together, I verily believe . . . ”



There are not many DX operators on the Island Republic of Dominica, in the West Indies—but here is one of them: Luis Caamano, HI8LC, P.O. Box 88, Sto. D.60, Dominica. He has a nice range of modern gear.



was running three watts—G3KPT has got over to W1TW on Fifteen with only two watts. Then there was the contact G2NJ-G2FWA, satisfactorily concluded when G2FWA was running two watts, although there was all the rumpus of a major contest going on around them. To cap this one, we hear of GW5TW, with 400 milliwatts, making a successful QSO with ON4TA when the latter was running 160 milliwatts, through all the QRM on Forty.

G3DCS accounts for his absence from these pages of late by explaining that he is having a go at RTTY, for which he has bought all the essentials and now has to make it all work. Enver is not beaten yet—he has persuaded the printer to print “the quick brown fox jumps over the lazy dog”—but the difficulty is that whenever he settles on some RTTY signal, regardless, this is the message that comes out. Must be a gremlin!

#### Awards & Contests

The weekend March 24-25 is going to be a busy one for the contest hounds. For a start the **CQ WW WPX Contest** is on, rules for which are as in past years. Thirty hours of the 48 can be used for operating, the rest of the time being “rest periods.” Double QSO points accrue for contacts on 160-80-40 metres and the prefix multiplier only counts once, *not* once per band.

Make sure your mailing address is one that will still be valid in a year from now, and send your entry to **CQ WPX SSB Contest Committee**, 14 Vanderventer Avenue, Port Washington, L.I., N.Y., 11050, U.S.A., to be postmarked no later than May 1, 1973.

The same weekend sees the **BARTG Spring RTTY Contest**, for which the exchange is to be time GMT, the QSO number and the RST. You may work 36 out of the 48 hours between 0200 on March 24, and 0200 on the 26th—just two hours later, start and finish, than the **CQ** affair just mentioned—and in this one you can work 36 out of the 48 hours. Contacts within your own country count two, other countries ten points. Multiplier is the sum of countries worked. Logs to be in by May 31, to G8CDW, 89 Linden Gardens, Enfield, EN1-4DX.

March 10-11 is another somewhat busy weekend for the operating enthusiast. There is the **YL/OM CW** contest, the **Israel International Contest**, and the **HF Phone WAB**, all over the same weekend. And of course, March 3-4 is the **ARRL DX Phone** contest weekend, and March 17-18 is the **ARRL CW**—a major contest, or more than one, on every weekend of the month.

On a more local level, we have notes of the **Grafton Top Band** contests for this year. March 24 is

the **AM** leg—March 31 the **CW**—April 7 the **SSB**—in each case running from 2130 to 0001z. Logs, postmarked not later than April 20, to B. Bond, G3ZKE, 86 Agar Grove, London, N.W.1 from whom also you can get copies of the rules and log sheets in exchange for an s.a.e.

An interesting award is the one being put out by A.R.I., for working a station in each of the areas where Marconi made his experiments—there are no less than forty of them, and in some cases it is necessary to have the card to specify the location, as G (Flatholm), U.K. (London), UA1 (Leningrad). This one looks like being a tough nut to crack—details from A.R.I., Via Scarlatti, Milano, Italy.

At the time this piece comes to be read, the University College of Wales have GB3UCW on the air to commemorate the College Centenary—the dates are February 26 to March 3. QSL's to: GB3UCW, University College of Wales, Aberystwyth.

#### Conclusion

There it is again; since all the “hard” news came in at the very last minute, apologies if anyone's pet snippet has had to be excised to get the late stuff into the space allowed. Keep 'em rolling, for a deadline of **March 13**, addressed “**CDXN**,” **SHORT WAVE MAGAZINE**, **BUCKINGHAM**.

## ADAPTABLE 30-WATT TRANSMITTER

COIL DATA — VFO  
COVERAGE — SETTING UP

### Part II

F. G. RAYER, A.I.E.R.E. (G3OGR)

**C**ONCLUDING from p.742, February, suitable coils are suggested here but there is no need that these should be exactly as given.

L1 has to allow coverage of the wanted band, or give this when V2 is doubling. L2 is broadly resonant in the wanted band, with stray circuit capacitances. Coils with adjustable cores, such as those mentioned, are most suitable. L3 can vary somewhat in length, diameter and wire gauge. Where an aerial will not load the PA correctly, a tuner or matching device should be added between Tx and aerial, in the usual way, or the length of a dipole be checked. With an end-fed wire, a tuner is useful to help reduce harmonics.

The *Denco* coils plug into B9A holders. For L3, two sockets are fitted to a strip of paxolin, and accept

wander plugs which are soldered to the ends of the PA coil winding.

PA grid current is higher when L1 is on the output frequency, than when V2 is doubling. Attempts to use V2 for greater frequency multiplication than 2x result in insufficient grid current.

### VFO Coverage

Where the full swing of VC1 covers too wide a frequency band, this can be reduced by increasing the value of C1 and reducing the inductance of L1, or by using a smaller value for VC1, or by taking plates off VC1. If wanted, further adjustment here can be provided by having a high-stability 50  $\mu\mu\text{F}$  or similar trimmer across VC1.

If much change is made from the values given here, note that oscillation may cease completely if the total of VC1 and C1 is too small. Also, should these values be too large, squegging can cause the VFO output to develop numerous frequencies which will be heard each side the wanted frequency. This is easily checked, if needed, with the aid of the receiver, with HT on V1 and V2 only.

### VFO Coil

For 160m., or 160m. and 80m. with V2 doubling for the latter band, L1 can be a *Denco* Yellow Range 3 coil, with point 1 to V1 tag 6, 9 to VC1, and 6 to 8

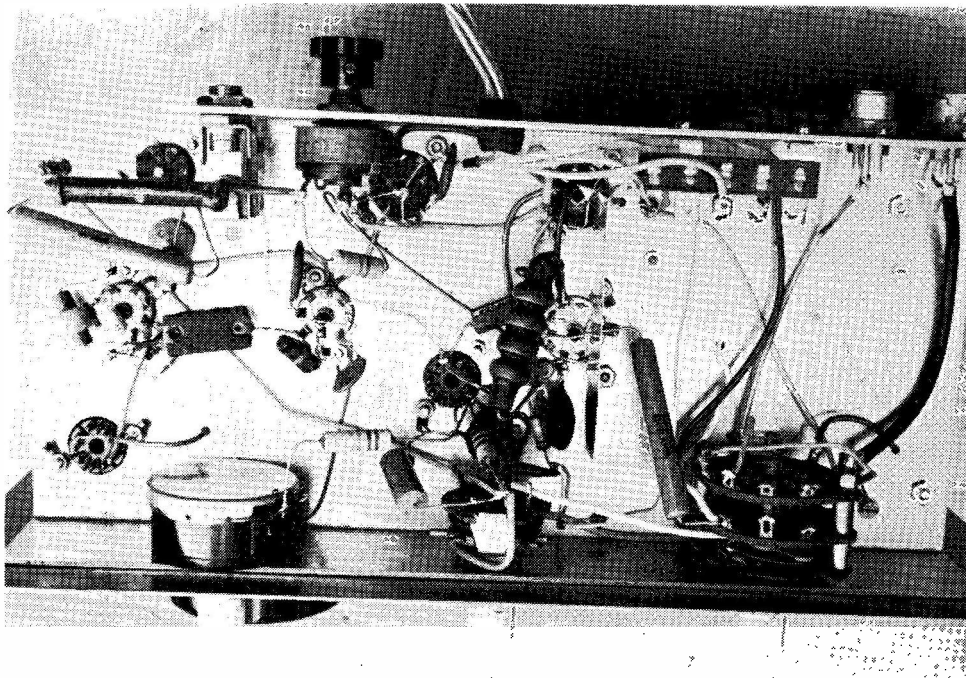

Layout under-chassis of the 30-watt transmitter—reference to the diagrams and the other photographs will help to identify items. The rear potentiometer is VR2, for clamp adjustment on V5. As shown by Fig. 1, p.741 last month, a 4-pole two-way wafer-type switch is needed for the on-off and change-over functions.

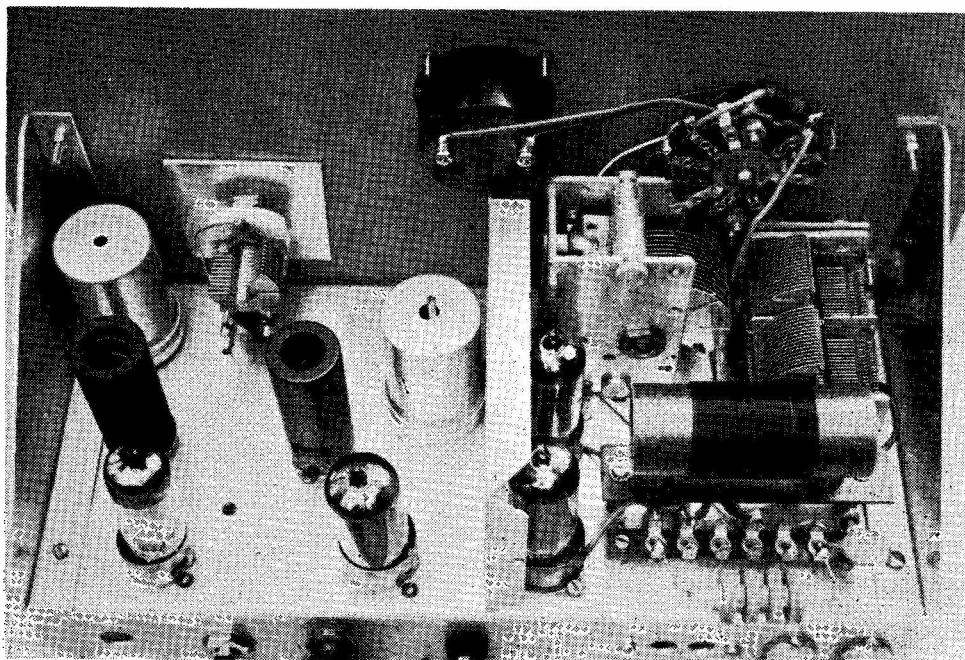

This picture should be read with Fig. 2, p.742, February, which will enable items to be identified in the correct positions. The two large cans to the left of the vertical screen are for the VFO and buffer coils.

joined. If VC1 is 75  $\mu\mu\text{F}$  and C1 is 150  $\mu\mu\text{F}$  1% or 2% silver-mica, suitable coverage should require nothing more than adjustment to L1 core.

For 80m., L1 can be a Yellow Range 3 coil, with the small winding removed, and also 12 turns taken off the tuned winding. A 50  $\mu\mu\text{F}$  capacitor is now actually sufficient for VC1 with C1 alone or C1 and a parallel trimmer, making up a total of about 185  $\mu\mu\text{F}$  in addition. The 3.5-3.55 MHz sector of this band doubles to 7.7-1 MHz for 40m. If more bandspread is wanted for 40m. alone, VC1 must be of smaller value, C1 (or the pre-set) being increased to make up. It is not possible to use one inductor or set of capacitor values which will allow full coverage of 3.5-3.8 MHz yet give large bandspread on 40m.

#### Buffer Coil

For 160m., a *Denco* Blue Range 2 coil is suitable, with the small winding removed. Peak the core for maximum grid current at about 1.9 MHz.

For the 80m. band, a Red Range 2 coil is suitable, with the small winding removed, and also 28 turns taken off the tuned section. For 40m., a White Range 3 coil, without its small winding, can be used.

In case other coils are tried, Blue Range 2 and Yellow Range 2 coils are for aerial and mixer, while Red coils are for 465 kHz IF osc. circuits, and White coils are for receivers with 1.6 MHz IF. Pin connections are thus different, and in order that any buffer coil can be plugged in, wire the holders (or pins) to suit.

#### PA Coils

A dual-band winding for L3 can be 50 turns of 22g. enam. wire side by side on a 1in. dia. tube. This allows working both 160m. and 80m. if VC2 is 500  $\mu\mu\text{F}$ , without too much loss of efficiency. However, it is essential to check that the PA is being correctly tuned to 160m. or 80m. as the case may be, so that the PA is not being used as a doubler. Also, only a narrower band of impedances can be matched.

For 160m. only, 65 to 70 turns of 22g. enam. wire side by side on a 1in. tube will be suitable. For 80m., 35 turns slightly spaced can be used, or 30 turns side by side. For 40m., 18 turns of 20g. wire spaced to occupy 1½ in. on a 1½ in. dia. tube will be suitable.

Other windings, and sundry surplus coils, would no doubt be satisfactory.

#### Checks

With V1 removed, adjusting the core of L2, or VC2 and VC3/4, should not produce any change in meter readings *at all*, for either position of the meter switch.

When the transmitter is loaded, and the key is up, there should be *no* RF output and *no* PA grid current. If there is, the PA is probably oscillating by itself, due to stray grid-anode coupling.

A domestic lamp (say 25w.) is suitable for AM tests or tests when the Tx is not keyed, but is unsuitable with keying due to its difference in hot and cold resistance.

If a back is wanted on the case, this should be open wire mesh to allow adequate ventilation.

## TWO AERIAL IDEAS

SIMPLE, PRACTICAL  
AND EFFECTIVE

THE current interest in *Oscar VI* has focused some attention—but not enough—on suitable receiving antennae for the 29.5 MHz “down”, or return, signal. It seems that many people are losing chances by not taking enough care with the 10-metre aspect of the operation.

Herewith a crossed-dipole arrangement of proven worth. The sketch is self-explanatory—except that instead of laying the array out flat, the apex of the two dipoles is pulled (or pushed) up so that the arms make about a 45° angle with one another. This calls for less than 6ft. ground-spread all four ways with the apex at a height of 7ft.+—these factors depending, of course, on how high the apex can be set. Note, however, that great elevation is not really necessary, so long as the ends of the arms are a few feet above “ground” level. An indoor or roof-space assembly would be possible in many cases.

With this arrangement, the feed-point impedance will be relatively low compared with that of a single horizontal dipole, though 50-ohm coax will make an acceptable match; probably it could be lower even than this.

If you are really keen about getting “resonance at the frequency”, a little juggling with a GDO would enable the arms to be trimmed, with your particular layout, to produce maximum aerial gain (pick-up) around 29.5 MHz.

The advantages of this sort of 10-metre array are that it is polarised virtually both ways, horizontal and vertical, and is also omni-directional—that is to say, it is the nearest thing to a satellite-following aerial that does not call for physical manipulation to keep hold of the 29.5 MHz signal.

Whether it is an attempt to improve results, overcome some local difficulty, or just the fascination of trying “a new aerial,” there is always something to be said or written or done in connection with that outside circuit on which at least 75 per cent of our reliance must be placed.

A particular problem is the multi-band aerial—something which will do well on several of our frequencies without a lot of matching and stubbing and tuning being necessary. Most of us know the usual methods of getting out on one or two bands, and there is very little difficulty about feeding a dipole on one frequency. But it is quite another matter to evolve a system which radiates reasonably well on frequencies lower than the fundamental, as for instance, 3.5 and 1.8 MHz when less than 100ft. of wire can be put out.

Look at p.27, showing a slight modification of the well-known Collins coupler.

The coil L is linked to the transmitter output tank and tuned with the two condensers C1 and C2, which are earthed at their mid-point, operation being as follows: With the link at the transmitter end disconnected,

All four arms = 95" each  
Coax length A-B = 96"  
Apex angle, about 45°  
both sets of arms

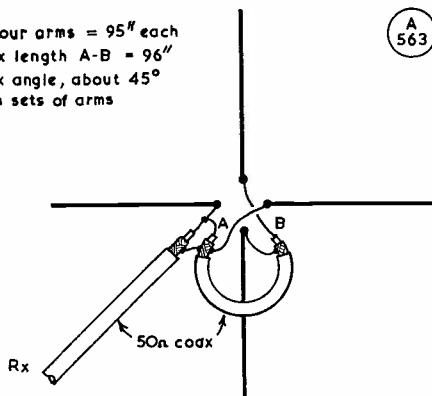

Crossed Dipoles for 29MHz

the output stage is tuned to dead resonance in the usual way. With C1 and C2 at minimum capacity, the link is then put on and C1 gradually rotated towards maximum till the plate current begins to rise. As it comes up, C2 is adjusted to keep the circuit in resonance, *i.e.*, minimum obtainable plate mA. Suppose PA plate current at dead resonance is 12 mA. On moving C1 it is pulled up to 35 mA; then by resonating with C2 it can probably be brought back to about 25 mA (on these figures). The process is continued till the normal loading of the PA is obtained, C1 being used to “draw,” and C2 to “resonate.” The degree of loading is thus controllable within very wide limits, a little preliminary experimental work with the links at transmitter and aerial tuner ends being desirable to ensure that there is enough coupling to allow the tuner to draw fully from the PA tank.

Of course, the usual precautions against overloading must be taken. The amount of draw should not be such as to “kill” the RF in the tank; the setting for highest output is where the RF as indicated by a loop-lamp or neon held near L is at maximum. If this is over the required input, either the links can be backed off or condensers C1 and C2 adjusted for lighter loading. It does not matter which, so long as resonance is maintained.

All the adjustments are made with the aerial on. Disconnecting the aerial after tuning will cause a large change in plate current—whether it is positive or negative depends upon the settings of C1 and C2 in relation to one another and the PA tank, and has no bearing on the operation of the system, since disconnecting the aerial puts the whole circuit out of tune. But the point is that there should be a change of plate current when the aerial is switched out—showing that it is taking load. Also, after having tuned the aerial side, it should be found that the PA tank condenser is still at dead resonance; that is, it ought not to be possible to reduce plate current any further on the tank side.

The theory of this system is simply that the circuit C1-C2-L can be made to match, within reason, any wire to any frequency. Our own tests shown that there is a certain amount of magic in the length of 85ft. Hundred-foot aeriels do not take well to the higher

The Matched End-on terminating circuit. C1, C2, should be 500 pF for all-band operation, 1.8 to 28 MHz or 300pF for 3.5 MHz and upwards.

frequencies like 14 and 28 Mc, and 60-70 foot wires are difficult to load up on Top Band.

**Values**

The fact remains, however, that if one can get up 85 feet of wire and use it with this matching circuit, effective radiation can be obtained on all bands Top to Ten. As to values, if 160 metres is required, C1 and C2 should be 500 μF and of a good low-loss design, and the coil L as follows: 1.8 MHz, 24 turns, 4in. diam., link 5 turns; 3.5 MHz, 18 turns, 3in. diam., link 3 turns; 7 MHz 7 turns, 3in. diam., link 2 turns; 14 MHz, 4 turns, 3in. diam., link 2 turns; and 28 MHz, 4 turns, 2in. diam., link 1 turn.

The length of the earth lead affects these values to some extent, so that suitable coils which happen to be available can be used to determine the best ratio for any band by shorting out a section turn by turn and then making L up accordingly.

Since the system works by adding sufficient inductance to the aerial to make it quarter-wave, half-wave, three-half-wave, full-wave or five-half-wave, it follows that the RF ammeter will show different readings from band to band, since its electrical position will alter considerably. That these readings are high,

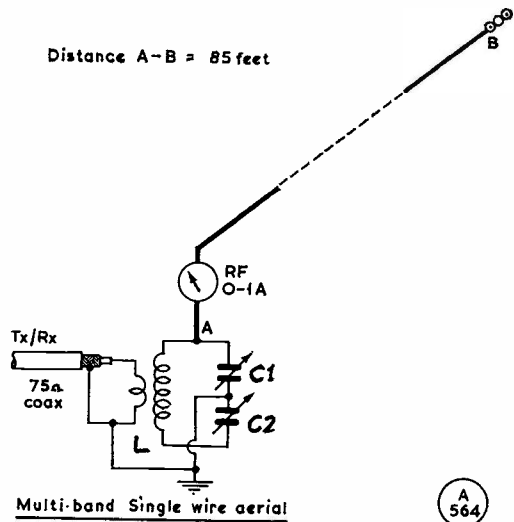

low or different is no indication whatever of the radiating efficiency of the aerial, and should only be used as a guide when coming back to a particular band setting.

## AERIAL CURRENT METER

### ADAPTING A STANDARD INSTRUMENT FOR RF

C. J. DAVIS (G3VMU)

THE non-availability of low current RF ammeters, the old 250 mA thermocouple type especially (and the sad end of the only one at hand, soon after the arrival of the licence) has led over the past six years to various methods of finding aerial current.

Of all those tried, the two shown here have proved the best. They are both empirical, but easy to build and operate. One uses the now ubiquitous toroidal core, the alternative being a 2½-inch length of ⅜-inch diameter ferrite rod. In each case the detector and indicator unit is the same and is dealt with first.

#### Detector and Indicator Unit

This is shown in Fig. 1 and is straightforward, using a single germanium diode with an RF filter unit. Any length of twisted cable can be used between it and the indicator. The unit poses no special problems at all, except to keep the diode in an earthed box to reduce, as much as possible, any harmonic radiation as diodes are good multipliers and can cause TVI.

A 100 μF electrolytic condenser is wired in parallel with the sensitivity control; this was an afterthought as the sound of the needle banging against the end of the

scale was annoying, SSB being used. The needle now falls rapidly to about one eighth scale and then slows down for the remainder of its traverse.

The meter used is a 19 Set instrument with the internal shunt removed—any meter of 500 micro-amp sensitivity would serve. The meter and sensitivity control can be mounted at the operating position.

#### Toroidal Transformer Unit

A Mullard FX-1593 toroid is wound with 12 turns of 22g. p.v.c. connecting wire spread evenly over the

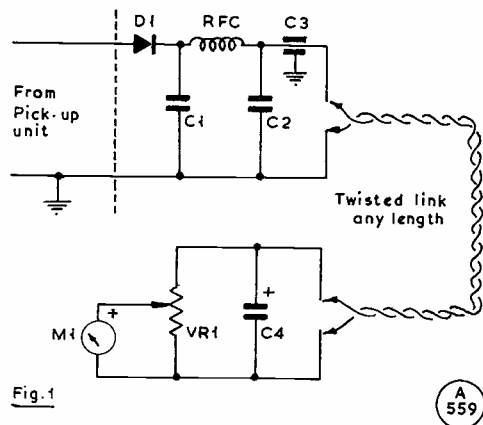

Fig. 1. Circuit of the RF meter, with indication remote from the pick-up point. Values can be: C1, .001 μF; C2, 0.1 μF; C3, .001 μF feed-thru; C4, 100 μF, elect. (see text). VR1, 10K linear; RFC1, 2.5 mH RF choke; D1, OA81 or OA79; M1, 0-500 microamp DC.

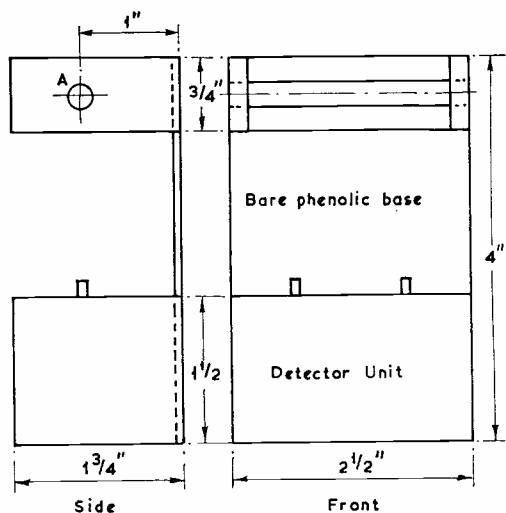

Fig. 2

Fig. 2. General construction suggested for the mounting of the Unit—the indicator can be remotely located. Hole A  $\frac{3}{8}$ -in. diameter.

circumference. This forms the secondary of the transformer, the primary being the aerial wire. This is not a whole turn, the toroid is simply slipped over the aerial lead. Any toroid of good frequency response will do for this purpose.

**Ferrite Rod Unit**

As toroids are not all that easily obtainable this pick-up was tried as an alternative, and is equal to, if not slightly better than the toroidal unit.

A piece of ferrite rod  $2\frac{1}{2}$  inches long by  $\frac{3}{8}$  inch diameter is wound centrally with 15 turns of 24g. enamelled wire. In this case the primary is half a turn of p.v.c. covered connecting wire near the secondary coil.

**Construction**

The head unit is built on a piece of printed circuit board  $2\frac{1}{2}$  inches wide by 4 inches long. The bottom  $1\frac{1}{2}$  inches are left covered with copper, the rest being etched away except for two areas  $\frac{3}{4}$  inch long by  $\frac{3}{8}$  inch wide, to which the aerial lead is soldered. A box is constructed from printed circuit board on the copper covered area to hold the detector and RF filter. After completion and checking a top is soldered on to form an RF-tight enclosure.

The toroid is self-supporting and the wires are just soldered to the lead-throughs. The aerial is run through the toroid, soldering it to the patches of copper for support.

Fixing the ferrite rod is a little more difficult but basically the same. Two cheeks of Perspex sheet are cut as shown in Fig. 2, drilled to take the rod and "Araldited" to the base board. The connections are as before.

The unit described is simple to use. Just tune the ATU for maximum keeping the reading on scale by

reducing sensitivity. A deflection can be obtained, on maximum sensitivity, of the carrier leak-through from the Tx with full drive on Top Band.

No trouble has been experienced with TVI in a fringe-area for Ch. 4, though it must be said that most operation takes place on 160 metres.

**COAX ADAPTOR FOR PLUG-SOCKET MATCHING**

D. E. KNOWLES (G3UVA)

WHILE there is a complete range of inter-series adaptors available for the types UHF, N and BNC coaxial fittings, many amateurs still use Belling-Lee TV connectors. As a great deal of both Japanese and American equipment uses UHF types and some ex-Service units are fitted with N-type sockets it was felt that a simple adaptor to convert to Belling-Lee would be useful.

On the surplus market are available right-angle adaptors for both UHF and N-type connectors. These are the basis of the new adaptor, and should be converted as follows: Trim off the fixing flange from the chassis-mounting type of Belling-Lee coaxial socket; this will now fit inside a spare back nut of any PL259 or N-type plug.

For the UHF type build up the pin thickness on the BL socket to be a push fit into the socket end of the right-angle adaptor, screw on backnut and the new adaptor is completed. For N-type, solder a short length of 16g. bare wire to the pin of the BL socket; this will then push into the centre pin at the socket end of the N-type right-angle adaptor. Assemble as with UHF type.

These simple adaptors will enable equipment with different coaxial fittings to be used with existing Belling-Lee type of installations. The adaptors can, of course, be used as they were originally because no alteration has been carried out. (See sketches below).

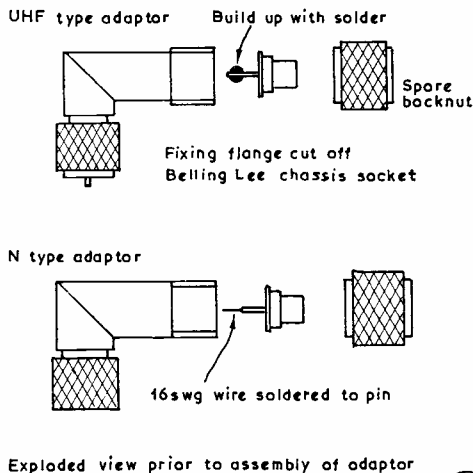

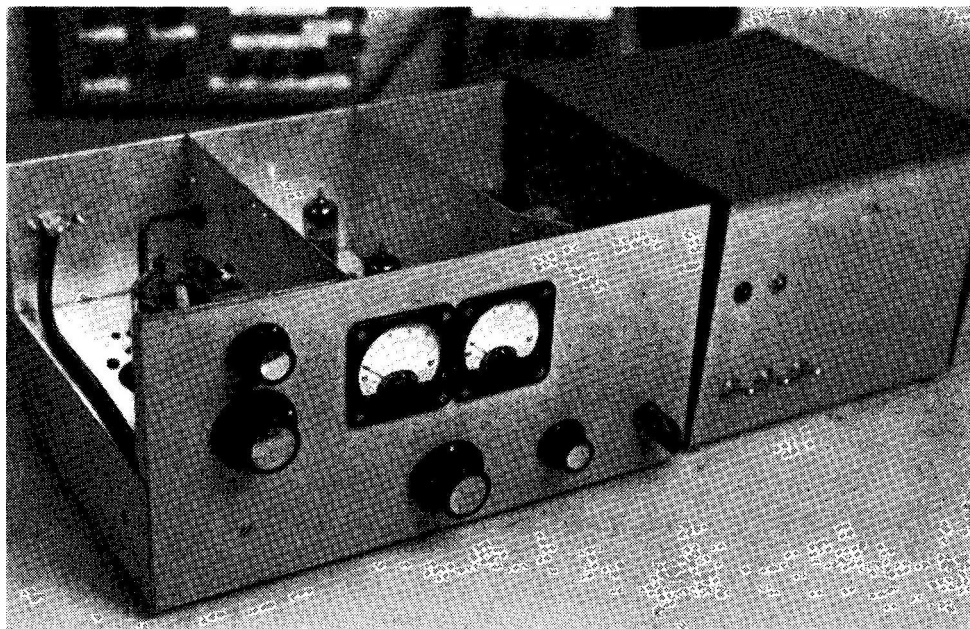

*SSB Transverter with PSU—general appearance*

## SIDEBAND TRANSVERTER FOR TWO METRES

### DESIGN AND CONSTRUCTION

J. D. V. Ludlow (GW3ZTH) and  
C. J. Dunbar (GW8EHK)

#### Part I

**T**HE attraction of using a particular mode of operation for communication on two metres revolves around the type of contacts in which the individual operator is interested. If the band is used primarily as a “natter-channel” for local ragchewing then QRP, AM or FM equipment often suffices, but for the operator who wants to work DX, CW or SSB are required to achieve a reasonable degree of success.

Whilst the advantages of using CW for DX working are well known there appear to be comparatively few two-metre operators using this mode. Thus, the use of SSB may include a greater return of DX contacts. This is especially true in the remoter areas of England, Scotland and Wales where often the local terrain is an additional obstacle to be overcome.

The methods of generating SSB on two metres are, alternatively:

- (a) Special purpose single-band filter or phasing generator, or
- (b) The use of an existing HF band trans-

mitter/receiver or transceiver and a transverter.

Alternative (a) assumes one has the necessary time and test equipment. While capable of producing excellent results it does imply single-band capability.

Alternative (b) calls for the construction of a relatively simple transverter, which requires only the use of the sort of test equipment found in most VHF stations, *i.e.*, multimeter, absorption wavemeter and if possible a reflectometer or SWR bridge.

This article describes the construction and operation of a two-metre transverter. The basic idea is to take the 10-metre output of an HF transmitter and with suitable mixing and amplification produce a SSB signal on two metres, the “receive” side being similar in that the incoming 144-146 MHz signals are heterodyned down to 10 metres where they are resolved in the normal converter/receiver set up. The choice of an HF band from which to start depends on the equipment available, although it should be noted that *as high a frequency as possible should be used* so that the difference in mixing and signal frequencies will be great enough to obtain maximum attenuation in the tuned circuits of the transverter.

The choice of 28-30 MHz as the SSB drive frequency was made to allow the facility of having VFO control over the whole of the two-metre band. However, 28-30 MHz is not the best area for minimising spurious and any would-be constructor is advised to choose 21 to 21.5 MHz and thereby reduce any possibility of inband spurious around 145 MHz.

(over)

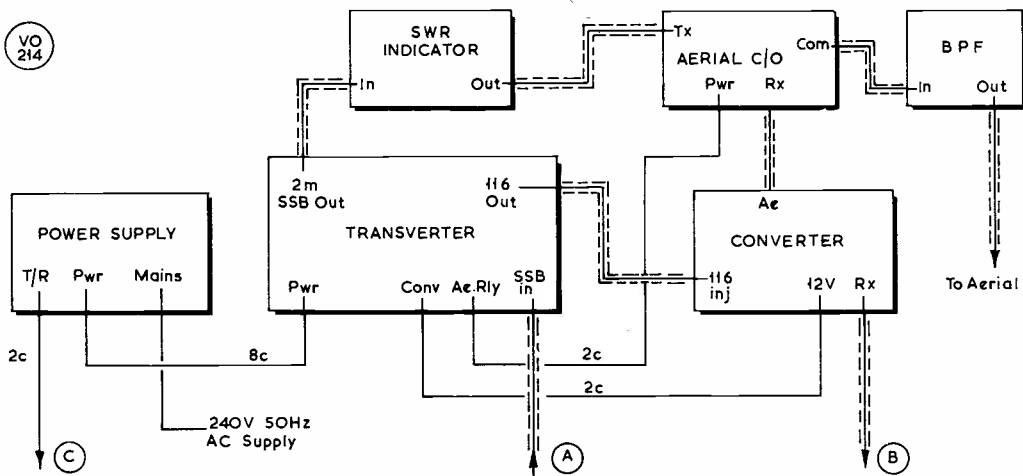

BLOCK SCHEMATIC — INTERCONNECTION DIAGRAM

Block Diagram — interconnection of Units

**Xtal Oscillator-Multiplier Chassis**

This is a four-valve unit, comprising two voltage stabiliser valves, an xtal oscillator and frequency multiplier.

Valves V1 and V2 are series voltage stabilisers and are included to regulate the HT feed to the xtal oscillator valve V3a and the frequency tripler V4. The tripler V4 was fed from this supply because it was felt that any variation in its HT would affect the loading on the xtal oscillator, thus introducing unwanted frequency modulation.

The oscillator V3 is in a conventional Miller circuit and has a typical frequency stability of 20 p.p.m. The xtal oscillator takes a 38-6666 MHz 3rd overtone xtal of the HC-6U variety. The point marked "x" on the diagram could be used to provide IRT/ITT or FM facilities by the inclusion of a varicap diode and suitable circuitry.

The output of the xtal oscillator is capacity coupled to V4, the frequency tripler, its 116 MHz output being inductively coupled to the balanced mixer and 2-metre converter.

Also included on this chassis is the T/R switching relay RL1/2 which is used for breaking the screen grid supply to the balanced mixer, buffer amplifier and PA stage. It could equally well be wired to apply a blocking bias to the PA stage should any unwanted hash due to PA shot noise be detected, also to provide a means of switching the SSB prime mover output from the converter on "receive" to the input network of the transverter on "transmit."

Due to lack of space on the balanced mixer-buffer amplifier chassis the 28 MHz SSB injection trimmer and input network are placed at the rear of this chassis; no problems have been experienced with this arrangement. The trimmer is used as the power level control

and not the microphone gain on the prime mover, thus preserving the carrier suppression of the prime mover.

**Balanced Mixer/Buffer Amplifier Chassis**

The heart of any SSB transverter must be the mixer, for it controls the quality of the final signal. This transverter is no different from any other, so the choice of mixer was made in the light of others' experiences. Whilst single-ended mixers will work, the authors felt that the possible level of spuri would be difficult to remove and so the balanced mixer was adopted. The choice of valves for the job is yet another matter, the QQVO3-10 being a convenient type; at a modest cost it fits the bill and has performed well in this role. The balanced mixer V5 is fed with the 116 MHz from V4 via a 1-turn link and with 29.41 MHz SSB to its cathode to give 145.410 MHz SSB at its anode. (The choice of 28-30 MHz as the injection frequency has been covered earlier). However, there is a problem around 29 MHz since the 5th harmonic is 145 MHz; cathode injection is to be preferred to balance out this component at the anode of the balanced mixer.

The output of the mixer is inductively coupled to the input of the buffer amplifier V6, another QQV03-10 run in Class-A at 8.9 watts with an available output of 2.3 watts—more than enough to drive a pair of 4CX-250B's to one kilowatt input! Again, the output of the buffer is inductively coupled to the grid of the PA stage.

**PA Chassis**

The choice of PA valve is a matter for the individual but it was felt that from the availability, cost and optimum performance point of view the ubiquitous QQV06-40A has much to commend it. There are, however, other possibilities such as the QQV03-20A for inputs up to 50 watts p.e.p.—another possibility is the 4X150A or 4CX250B stage with the advantage of increased talk-



power.

With regard to the existing PA stage it is possible to run the QQV06-40A at inputs up to 200 watts p.e.p., providing caution is observed in the tune-up procedure.

### Construction

The transverter was constructed in its present form as a result of experience with an earlier design. Each chassis is screened from its neighbour to reduce any unwanted coupling effects. (The chassis screens and wrap-over cover were made professionally, so much of the hard work was eliminated). There are other lay-out possibilities, but one word of warning: Good and effective interstage screening is a "must" if stability is to be maintained and spurious are to be kept at a low level.

The layouts (given in Pt. II) are as a guide for the would-be constructor. The main point to watch out for is the chassis hole that receives the QQV06-40A PA valve. To maintain stability this should be just right to allow the valve to be seated into its socket and for some cooling air to flow around the valve, a little over 2in. being the optimum size.

In the prototype it was found that the buffer amplifier was unstable and after a considerable amount of blood, sweat and tears had been shed the present design evolved. Grounding of the buffer cathode is to be preferred, the cathode being taken to earth by means of a tag adjacent to its valveholder pin.

The rest is straight forward VHF practice with the liberal use of .001  $\mu$ F disc ceramic capacitors with short leads, reducing long leads to a minimum and taking care to avoid any unwanted coupling between components. It cannot be emphasised enough that good quality components should be used, even if they are rescued from the junk-box. Clean off all leads even if the components are brand new as one bad solder joint can cause a considerable amount of trouble.

A large number of disc ceramics are used for decoupling; these have been included to prevent the possibility of unwanted coupling and should be wired as close to their associated stage as possible.

### Alignment

With the construction completed a resistance check should be made to make sure there are no shorts. If all is well the valves can be inserted and the heater supply connected. Check the filament voltage of each valve at the pin itself—all should be 6.3v. A.C. Next connect the bias line to the -50v. rail and set the PA bias to -35v.; the buffer amplifier bias volts should be at least -21v. A slightly higher voltage will be necessary at anode voltages above 290v. in order to keep the anode dissipation within the manufacturers' limits; this can be corrected by increasing the value of R14 proportionally.

Then the 300v. supply can be connected. The stabiliser valves V1 and V2 should both strike and the HT across them measured; this should be a nominal 193v. The oscillator anode coil is then adjusted for maximum output, the core being set to ensure reliable starting. Check that the crystal is oscillating on its 3rd overtone; Tc2 should be peaked for maximum 116 MHz output by using a loosely-coupled calibrated absorption wavemeter.

## Table of Values

Fig. 1. Circuit of the SSB Transverter

C1 = .002 $\mu$ F, disc	VC3 = 5 + 5 $\mu$ F, wide spaced
C2 = 30 $\mu$ F, s/m	VC4 = 5-25 $\mu$ F, wide spaced
C3, C4, C5, C6, C7, C9, C13, C15, C16, C17, C19, C20, C21, C22, C23, C26, C28, C29, C30, C32, C33, C34 = .001 $\mu$ F, disc	R1 = 180,000 ohms, 2w. R2 = 150,000 ohms, 2w. R3 = 100,000 ohms, 1w. R4, R5, R11, R16 = 47,000 ohms, $\frac{1}{2}$ w. R6, R12, R13 = 100 ohms, $\frac{1}{2}$ w. R7 = 3,000 ohms, w/wound R8, R10 = 1,000 ohms, 1w. R9, R18, R19, R20 = 120 ohms, 1w. R14 = 2,200 ohms, 1w. R15 = 2,700 ohms, 1w. R17, R21 = 10 ohms 5w., w/wound
C8, C10, C14 = .047 $\mu$ F, disc	VR1 = 5,000-ohm w/wound pre-set pot.
C11, C12, C18, C24, C25, C27 = 470 $\mu$ F, disc	MS = Meter shunts, as required
C31, C35 = 68 $\mu$ F, 8kV wkng., disc	RL1/2 = Relay, 12v. DC coil, 2-pole c/o
Ft1, Ft2, Ft3 = .001 $\mu$ F 500v. feed thru	V1 = OB2, 150v. V2 = 85A2, 85v. V3 = ECC81 V4 = EF184 V5, V6 = QQV03-10 V7 = QQV06-40A.
Tc1 = 3-30 $\mu$ F beehive trimmer	
Tc2 = 5-50 $\mu$ F trimmer	
Tc3, Tc4 = 5 + 5 $\mu$ F butterfly	
VC1 = 5-50 $\mu$ F, ins. above ground	
VC2 = 5 + 5 $\mu$ F butterfly	

Notes: All resistors 10% tolerance carbon, except where stated. C31, C35 high-voltage RS Components disc cap "ionisation free". Adjust R14 for anode dissipation of 8-9 watts. Wide-spaced capacitors VC3, VC4 should have plates at .045 in. spacing. Preferred crystal frequency is 38-6666 MHz. HC6/U or HC18/U type. RF chokes RFC1, 2, 3, made with quarter-wave (approx. 20in.) of 30g. enam. wound on 1K 1-watt carbon resistor body.

## Circuit on p.p. 32 & 33

### Table of Coil Data

L1 = 11 turns 30g. enam. close-wound on $\frac{1}{8}$ in. dia. poly former with dust slug.
L2 = Three turns 16g.
L3, L4 = One turn 18g. loose-coupled to L2.
L5 = Filter suitable for 28-30 MHz.
L6 = One turn 18g. at centre L7.
L7, L8 = Two-by-two turns of 16g.
L9 = One turn 18g. centred on L8.
L10 = As L9, centred on L11.
L11 = Four turns 16g., centre tapped.
L12 = Two-by-two turns 16g.
L13 = One turn 18g. centred on L12.
L14 = Two turns 18g. centred on L15.
L15 = Two-by-two turns of 16g. connected directly across V7 grid pins.
L16 = Two-by-two turns 14g., wound to $\frac{1}{8}$ in. i.d.
L17 = One single turn at L16.

Note: Except where specified, all coils are half-inch diameter self-supporting, spaced one wire dia. between turns. Coils may need slight adjustment for resonance.

(To be concluded)

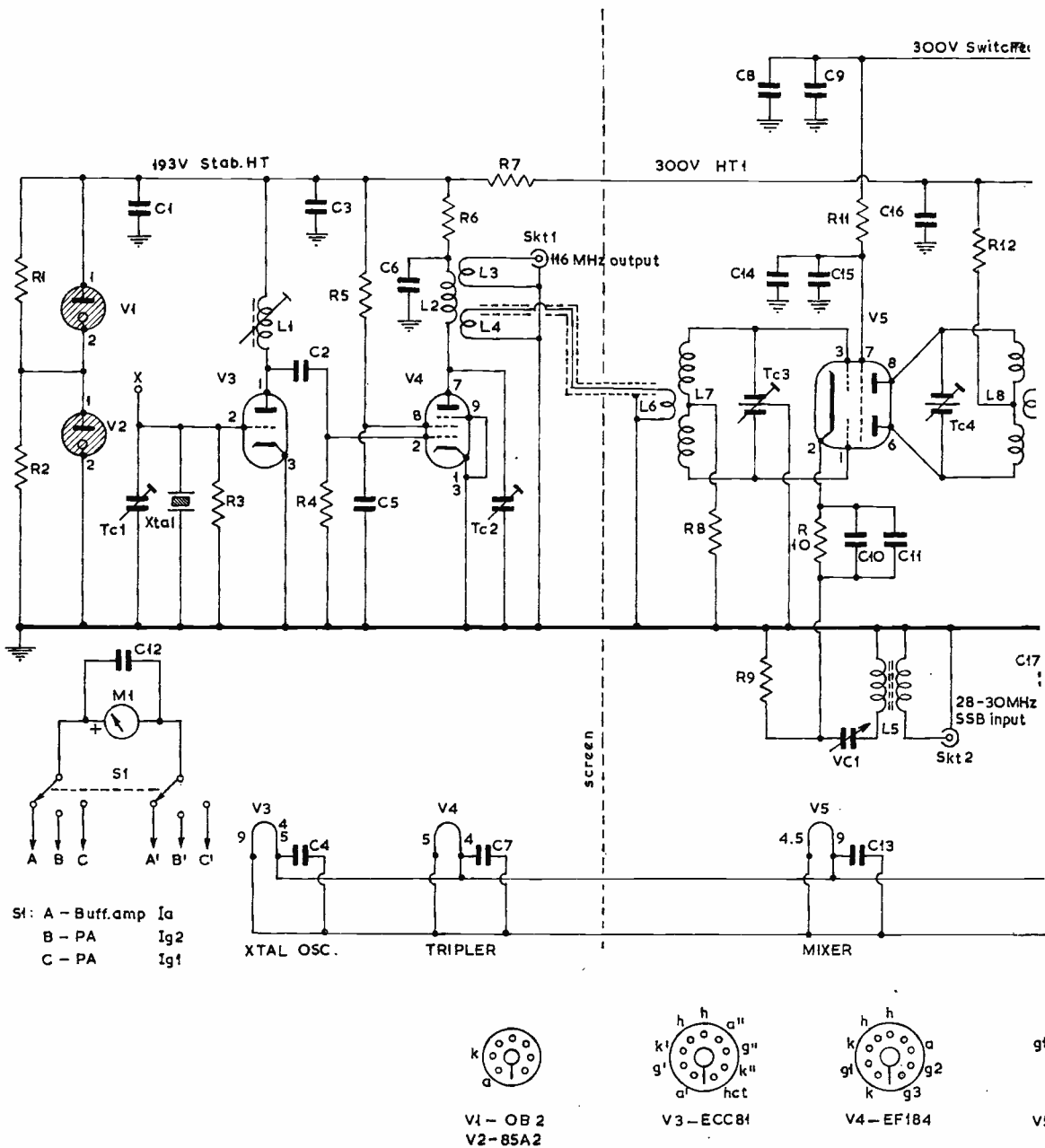
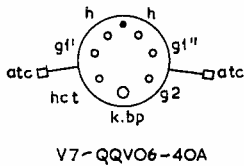
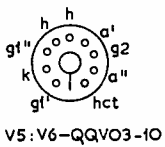
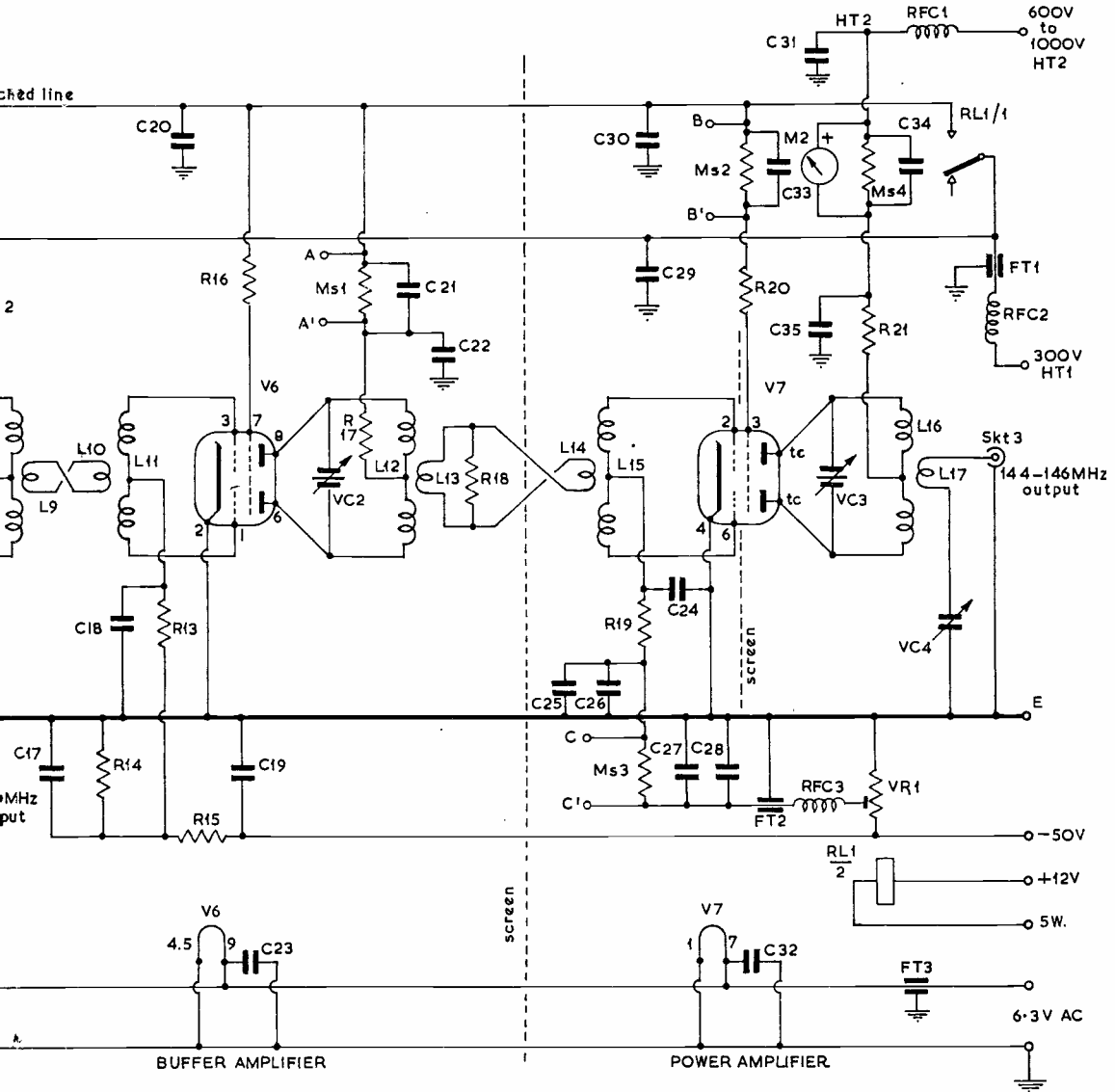

Fig. 1

Fig. 1. Circuit of SSB Transverter, 28 to 144 MHz



### THE MOBILE SCENE

The Rally dates are filling up fast—we should be informed of further fixtures before March 13, for appearance in the April issue of *SHORT WAVE MAGAZINE*. Address to “Mobile Scene” on a *separate* piece of paper, please.

**April 1st:** Annual White Rose Rally, at the High School, Ring Road, West Park, Leeds 16, junction of the A.6120 (ring road) and A.660, opening at 11.30 a.m.—R. J. Nettleton, 129 Stainbeck Lane, Leeds, LS27 2EB, for details.

**April 15:** North Midlands Mobile Rally at Drayton Manor Park, near Tamworth, as last year.

**May 6:** Tulip-Time Rally, at Sunfleet on the A.16, four miles north of Spalding, Lincs.—Information from R. Harrison, G3VPR, 38 Park Avenue, Spalding, Lincs.

**May 13:** South Leicestershire Mobile Rally at Westfield Activity Centre, Rosemary Way, Hinckley, opening at 11.0 a.m. Trade stands are to be organised and applications are invited. Details from J. Elliott, G8CGW, 92 Hinckley Road, Barwell, Leicester.

**May 20:** RAIBC gathering at the Fairground, Broadlands Estate, Romsey, Hants., in conjunction with the Southampton Group.—Mrs. Frances Woolley, G3LWY, Woodclose, Penselwood, Wincanton, Somerset.

**May 27:** Hull & District Mobile Rally at Bishop Burton, near Beverley, Yorkshire. Organiser L. D. Colley, G3AGX, 13 Ferry Road, Wawme, Nr. Hull, HU7 5XU, East Yorks.

**May 27:** Maidstone Mobile Rally at YMCA Sports Centre, Melrose Close, opening at 11.0 a.m. All main events under cover, talk-in by GB3YSC on 2-4-80-160m. Contact A. S. Walter, G3WXL, 4 Oak Farm Gardens, Headcorn, Kent.

**July 8:** Upton-on-Severn Mobile Rally, organised by the Worcester & District Amateur Radio Club. Details: B. A. Jones, G8ASO, 12 Woodside Road, Larkhill, Worcester, WR5 2EG.

**August 12:** Torbay annual Mobile Rally at Newton Abbot Rugby Club ground, with talk-in, the usual stands and competitions.—L. H. Webber, G3GDW, 43 Lime Tree Walk, Newton Abbot, Devon.

**August 26:** Town & Country Festival Rally, National Agricultural Centre, Kenilworth, Warwickshire.

**August 26:** Preston Amateur Radio Society Rally, details later.—G. Earnshaw, 12 Withy Parade, Fulwood, Preston, Lancs.

---

### SOLO MOBILE EXPEDITIONS

It may be remembered that some years ago, at the suggestion of G3HBZ/M (Sunbury, Middlesex) we

sponsored Sunday-afternoon mobile operating periods—the idea being merely to go out, picnic-wise, and see what other /M's could be worked, perhaps from some static site on high ground, or however (p.107, April 1967 *SHORT WAVE MAGAZINE* refers).

There is no reason why we should not try this again, there having been many more U.K. mobiles licensed during the last six years. Accordingly, we suggest the following Sunday-afternoon dates (about noon to around 5.30 p.m.) during which this ploy might be tried: April 8, May 20, June 10 and July 8. If reports to “Mobile Scene” could be sent in immediately after these tests, results could be covered in the *Magazine* issue following.

We also have some other ideas in mind to encourage what might be called “mobile working with an objective”, and generally more activity /M as between mobiles.

Anyway, try one or two of these Sunday jaunts, see what happens and let us know, giving own map location (if static) and callsigns and localities of mobiles worked. Use any band for which you are equipped /M. Write in to “Solo Mobile Expedition, Mobile Scene,” *SHORT WAVE MAGAZINE*, BUCKINGHAM.

---

### SPECIALLY ON THE AIR

This heading covers those amateur-station activities involving a public appearance or demonstration of Amateur Radio, for which the Ministry will issue a special “for duration only” callsign, with a named licensed amateur as being responsible for the operation of the station. Such special-activity stations as are notified to us will be publicised in this space.

Please send in on a *separate* sheet, before March 13 for the next issue. We also need the name, callsign and QTH of the responsible contact-man.

**GB3STF, May 12-13:** From the Grammar School, Priory Road, Spalding, Lincs., by the Spalding & District Amateur Radio Society, running CW/SSB on all bands 10-160m. (and AM on two metres), all contacts to be confirmed by special QSL card—Details from R. Harrison, G3VPR, 38 Park Avenue, Spalding, Lincs.

**GB2BWS, May 30-June 2:** For the Bath & West Show, from the Shepton Mallet, Somerset, showground. Loan of equipment and operating assistance are solicited, conferring free admission for car and/or caravan. Anyone who can help is asked to get in touch with R. B. Holman, G2DYM, The Old Saw Mills, White Ball, Wellington, Somerset.

**GB2GB, August:** Station to be operated from Brunel's old steamship *Great Britain*, now dry-docked at Bristol, for the City's charter anniversary celebrations. GB2GB will be available for operation by visiting licensed amateurs during the entire month. Contacts will be QSL'd by special card. Information from G. Mather, G3GKA, 8 Hills Close, Keynsham, Bristol.

# VHF BANDS

A. H. DORMER, G3DAH

## Oscar VI

THIS has been another frustrating month for users of the satellite, with many predicted orbits inactive and many of those which have produced results difficult to work because of weak signals and much QSB. It is known that some of the trouble is due to a fault in one of the solar cell panels which has resulted in low battery voltages, but AMSAT have now announced that there is a mal-function in the satellite control system as well. In order to conserve power (and thereby relieve the frustration) they propose to switch the transponder off from 0001z on Mondays until 2359z on Thursdays. The 70 cm. beacon and the telemetry will be transmitted at the start of the first orbit after 0001z each day—well out of range of the U.K. *Oscar VI* may be heard between these times but operators are requested *not* to use it. In this way it is hoped that a full weekend service may be maintained.

Oscar CW procedures are being speeded up still further as operators become more familiar with working through it. Since most stations are listening through on 10m., it frequently suffices to send "BK", or just your call, or a string of dots to attract the attention of the calling operator, who then sends "K" and away you go. Neat? Adequate!

One might mention at this point that the plans for *Oscar VII* are well advanced. This will be a 2m/70 cm. transponder in a nearly synchronous orbit giving 180° coverage and should be on view for 10 days at a time.

Project "Moonray" is still on the stocks and should put a repeater on the moon in 1976, all being well.

## Extracts from Reports

GW3FSP has now had 442 contacts *via* Oscar of which no less than 147 are with W/VE. He is finding it a bit of a job to work new calls now, and it seems to be the opinion of many that we are reaching saturation point. He has certainly been one of the most consistent performers—one rarely hears a pass without Dewi's impeccable CW. He uses the Tx which was on display at the 1966 Exhibition at the Seymour Hall, with a pair of 4X150's in the PA, a 10-ele. *J-Beam* and a TH3J for 29 MHz. Rx has the HQ-170A. He comments on the 2m. beacons which translate quite nicely to 29 MHz on some passes, thereby taking up band space and output power in the satellite, but short of switching them off during in-range passes, it is a bit difficult to know what could be done about it.

Another consistently good signal on most passes is that of G3JVL, with over 300 contacts with 106 different stations through the device. His comments are of great value, therefore. He runs a 4CX250 PA in the Tx and after many trials has settled on the following for the antenna systems: On 10m. he uses

a dipole of  $\frac{1}{2}$ in. dia. aluminium tube at 32ft., and 5ft. below that, a 7-ele. Yagi tilted at 40° to the horizontal. The latter gives better overall results than the 2m. dipole, which failed for overhead passes, and better than the 10-ele. horizontal Yagi. Obviously in this, as in most cases where amateur operation is concerned, there is need for a compromise. The 10-ele. beam still gives the best results at the low radiation angles required for the more distant orbits, but the tilted antenna, with a broadened lobe in elevation resulting from a reduction in the strength of the ground-reflected signal, gives the best general coverage. Mike stresses the importance of the 10m. Rx. If galactic noise does not predominate, then the Rx or the antenna is at fault. A simple way to check this is to replace the aerial with a 50 or 75-ohm resistance and note that there is a substantial increase of noise with the antenna connected—in other words, that the only substantial noise-effect in the Rx is that produced by the aerial. The receiver must then "hear" any signal which is above Ae. noise. (And CW can, of course, usually be read under it.)

De-sensitisation of the Rx by the 2m. Tx is also a factor, and using a low-pass filter between the antenna and Rx helps a lot here. G3JVL

## OSCAR VI — Prediction Data

Orbit	Date	Time (GMT)	Position	Direction	
1736	Mar. 3	0820	23°E	N/S	
1737		1015	06°W	N/S	
1738		1210	35°W	N/S	
1741		1731	35°E	S/N	
1742		1926	06°E	S/N	
1743	Mar. 4	2121	23°W	S/N	
1748		0720	38°E	N/S	
1749		0915	09°E	N/S	
1750		1110	20°W	N/S	
1754		1826	21°E	S/N	
1755		2021	08°W	S/N	
1911		Mar. 17	0744	31°E	N/S
1912	0939		03°E	N/S	
1913	1134		26°W	N/S	
1916	1655		44°E	S/N	
1917	1850		15°E	S/N	
1918	2045		14°W	S/N	
1919	2240		43°W	S/N	
1924	Mar. 18		0839	18°E	N/S
1925			1034	11°W	N/S
1926			1229	40°W	N/S
1929		1750	30°E	S/N	
1930		1945	01°E	S/N	
1931		2140	27°W	S/N	

Notes (1) Times shown are for crossings at 52°N. (2) Orbits beyond 45°E or W are not included. (3) To calculate later orbits, deduct 5.15 minutes and add 1.29°E each 25 orbits. (4) Orbits shown are for weekend operations only in view of the AMSAT procedure, for which see text.

notes in passing that DJ2RE (with whom he has now had 16 QSO's) has had 620 Oscar contacts to date! In spite of his excellent set-up, 'JVL had yet to work GM!

G4AJC now has 20 countries to his credit, all worked with a QQV06-40A PA, a 2-ele. beam on 10m. and a tiltable 9-ele. on 2m. He finds that, on some orbits which are ostensibly beyond range he can still hear and indeed has worked some good DX. G4ATX has joined the ranks of the Oscar chasers (one doesn't hear too many G4/3's) and comes up with 13 countries in 26 contacts. He runs an 8-ele. beam on 2m. and a dipole on 10m. Tx is a QQV06-40A and Rx a Somerkamp FR-DX500. GM3ZVB uses a 10m. dipole and an 8-ele. beam, slightly tilted, for his Oscar contacts. He comments that for accurate netting an oscillator on 116.5 MHz and a mixer would bring up the 2m. signal on the correct 10m. frequency on the Rx. Very useful when one cannot hear one's own signal.

G5ZT notes that there appears to be an excessive time delay in the return of one's own signal on 10m. Has anyone else noticed this? EI6AS reports that VE3QB is the Canadian control station for Oscar.

G3IOR has had some very fine DX—best to date with W5ORH at 4,556 miles and he is awaiting confirmation of a QSO with W7BBO at 4,741 miles. He has also heard some remarkably good stuff, including KL7, UAØ, JA9, HM, FY7, OX and XE. The gear runs 10 watts to a '320A with a 6/6 inclined at 7° to the horizon. The Rx has a really hot front end (0.05  $\mu$ V for 3 dB sig./noise ratio) and the 10m. antenna is a 3-ele. Yagi at 50ft. He recommends a simple FET pre-amp on the Rx rather than excessive power, and his list of countries heard seems to justify his comment.

The G3NHE total includes an unusual one in FC, which doesn't figure in any other list, and he has at last got his YU after spending much time calling (and who hasn't?) the gentleman in that country with the cloth ears. Martin makes a couple of interesting points. The first is the practice of tilting the 2m. antenna above the horizontal which must degrade the performance at extreme range. (*Vide* comments by G3JVL above). To coin a phrase, "Circum-

stances alter cases", and the results achieved are probably best evaluated empirically, since soil conductivity and wavelength above ground both play a part. The second concerns reception from beyond the horizon commented upon by several readers. He suggests that the mechanism is bending or refraction, and this seems very likely.

A very complete set of Oscar predictions comes from G3WPO, QTHR, who is prepared to send copies to readers each month on receipt of an s.a.e. To forestall the inevitable questions as to why they apparently conflict with our own predictions, it may be noted that the times and bearings given by G3WPO are for S/N equator crossings, whereas the *Magazine* figures are for transits at 52°N irrespective of pass direction. A correction factor applied to either set of figures will give the correct answers. With the predictions goes a set of tracking tables and a cursor which enable the elevation at any point and time to be computed. A very public-spirited gesture for which many thanks, Tony. The antennae in use at G3WPO are a bit complex, consisting of two, three-ele. phased beams at 60° to the horizontal and pointing South and North respectively and these, together with the 10-ele. Yagi, do the job very nicely, as the Table shows. Power used is varied to suit the conditions—it can be as low as 20 watts when conditions are right, but needs to be a lot more than that for some passes.

Finally, a report from SWL Gordon Smith of Aberdeen. Not only has he knocked up 31 countries heard, but he also advises that GM8FTJ is "Oscaring" on SSB and GM3AXE on CW. He uses two aerials, a long wire for East/West and a dipole for North/South coverage. His log includes GM and LX which do not often figure frequently in other logs.

#### Contests

It has hardly been the month for outstanding propagation during any of the VHF contests, although the 2m. SSB event produced some fair results, and the 2m. CW on February 4 saw a certain amount of EU activity.

#### 70 cm. Cumulatives

That on January 4 was pretty poor, although G3KMS (Bolton,

Lancs.) worked G8AHF in I.o.W. and finished up with a total of 134 points including three 9-pointers and one 11-pointer. G8AWS/P was on from near Chester with SSB. Arthur is still in the forefront of 70 cm. activity, as witness the picture on "VHF Bands" last month. The GB3SC signal was very weak at this time. Propagation was average for the January 12 session, although G4AEQ (Manchester) heard G3KEQ in Surrey. Best score noted was G3KMS with 23 contacts for 132 points, others being around the 10-12 contacts mark. Activity was low, possibly due to the frost and snow, several stations reporting inability to get on the air due to aerial icing. The January 20 event was even quieter, again the bad weather may have had something to do with this. Things perked up a bit for January 28; for example, GD2HDZ was heard well in the Midlands, but scores still but rarely passed the 18-20 contact mark. The February 5

#### OSCAR VI TABLE Operating Results

Station	Countries	Prefixes
G6RH	32	DL, DM, EA, EI, F, G, GI, GU, GW, HB, HG, I, LA, LZ, OE, OH, OHØ, OK, OM, OX, OZ, PA, SM, SP, SV, TF, UA, UG, UT, VE, W, 4X4, YU. (186)
GW3FSP	32	DL, DM, EA, EI, F, G, GI, GW, HB, HG, I, LA, LZ, OH, OHØ, OK, ON, OZ, PA, SM, SP, UA, UB, UG, UK, UR, UT, UW, UY, VE, W, 4X4 (442)
EI6AS	31	DL, DM, EA, F, G, GI, GW, HB, HG, I, LA, LX, LZ, OE, OH, OHØ, OK, ON, OZ, PA, SM, SP, UA, UG, UK, UR, UY, VE, W, YO, YU. (329)
G3NHE	30	DL, DM, EA, EI, F, FC, G, GI, GW, HB, HG, I, LA, LZ, OH, OHØ, OK, ON, OZ, PA, SM, SP, SV, TF, UA, UG, UR, VE, W, YU. (335)
G3BHW	30	DL, DM, EA, EI, F, G, GI, GW, HB, HG, I, LA, LZ, OE, OH, OK, ON, OZ, PA, SM, SP, SV, TF, UA, UG, UR, UT, VE, W, YU. (194)
G3WPO	29	DL, DM, EA, EI, F, G, GW, HB, HG, I, LA, LZ, OE, OH, OK, ON, OZ, PA, SM, SP, UA, UF, UG, UK, UR, VE, W, YO, YU. (139)

session was also bedevilled by poor propagation conditions in spite of the comparatively high pressure (1035 mB in Herne Bay).

### Two Metres

The CW contest on February 4 saw some good EU/DX with DJ9DL and DC6EQ well to the fore, together with a handful of PAØ and F, although final scores did not seem to reflect intense activity. It looked as if the Midlands had it rather better than the South, the two Sheffield stations G3NHE and G3NEO being well up towards the end. The increasing use of the VFO was most noticeable during the contest, with co-channel QSO's very frequent. Little abuse of the method was observed.

The Grafton Radio Society VHF Contest was won by G8GHA/P with 254 points, the runner-up being G8GCS/P.

### Four Metres

The last of the Four-Metre Cumu-

G3JVL	28	DL, DM, EA, EI, F, G, GI, GW, HB, HG, I, LA, LZ, OE, OH, OK, ON, PA, SM, SP, SV, TF, UA, UG, UR, UT, VE, W. (300)
G3IOR	26	DL, DM, EA, EI, F, G, GI, GW, HB, HG, I, LA, LZ, OH, OHØ, OK, ON, OZ, SM, SP, UG, UK, UR, VE, W, YU. (198)
G3COJ	23	DL, DM, EI, F, FP8, G, GI, GW, HB, HG, I, LA, LZ, OH, OK, PA, SM, SP, SV, UA, UG, VE, W. (?)
G5ZT	20	DL, DM, EI, F, G, GI, GW, HB, HG, I, LA, OH, OK, ON, OZ, SM, SP, UA, VE, W. (?)
G4AJC	20	DL, EA, EI, F, G, GI, GM, GW, HB, I, LA, OH, ON, OK, PA, SM, SP, UA, VE, W. (250)
G3DAH	18	DL, DM, EA, EI, F, G, GI, GW, I, LA, OH, OK, SM, SP, UK, UR, W, YU. (72)
G4ATX	13	DL, F, G, GW, HB, OH, OK, ON, PA, SM, SP, UA, VE. (26)

It is intended that this Table shall run for the duration of *Oscar VI* activity. When putting in a claim, please show countries worked in alphabetical order, as given here, with total contacts made *via Oscar* in brackets. To keep the Table up-to-date, claims should be made monthly. It is open to U.K./EI 2m. operators only and at present no award status for working through *Oscar VI* is contemplated. Contacts *via Oscar* do not count for VHFCC Awards. Claims for entry in this Table should be made to "VHF Bands", SHORT WAVE MAGAZINE, BUCKINGHAM.

latives took place on January 14 and 28th. Here again, conditions were not very favourable for long-haul contacts. Best signal in the South was G3OHH (Mow Cop), a very reliable performer. Both the beacons were well down on both dates.

*Forthcoming Events:* March 3/4 for the 144/432 MHz Open and March 4 for the 144 MHz Fixed Station events. March 31/April 1 for the 432 MHz Open.

### VHFCC Awards

Joe Ludlow, GW3ZTH of Bridgend, Glamorgan, heads the list this month with Award No. 176 for two-metre contacts. From his QTH at 450ft. a.s.l. four miles inland from the Bristol Channel, he finds propagation good NW-S-SE, average SE-E-NE and poor NE-N-NW due to the surrounding terrain. He runs an FT-101 into a transverter with a '640A in the final, which gives him about 200 watts p.e.p. The antenna at 30ft. is an 8-ele. Yagi, to be changed shortly for a 10-ele. Skybeam or something bigger, and this is fed from the Tx *via* an SWR bridge and a bandpass filter. The converter uses dual-gate mosfets (3N140's) in the two RF stages, with a 40602 mixer. Future plans include QRO operation with 4CX250B's.

There follows Mike Stevens, G8FBN (Freemantle, Hants.) who gains Award No. 177, also for two metres. He has been a keen SWL since he was 14 years old and recalls that his early Rx was a home-built job with plug-in coils! He was first licensed in August, 1971, and still runs an HW-17A with 8-10 watts output into an 8/8 at 45ft. He has an FR-DX400 and an Eddystone 870A against the time when his G4/3 call arrives.

From Luton in Bedfordshire, Mike Costello, G3YPP gains Award No. 178. He has been on 2m. for nearly three years now, and in the early days ran a QQV02-6 in the final but has changed this for a QQV03-10 with 15 watts into an 8-ele. beam at 36ft. The Trio Rx is preceded by a double-conversion, dual-gate mosfet converter. Mike is now at Swansea University and operates from there on the HF bands as GW3YPP. Whether he gets back on 2m. or not depends upon the breakthrough from GB3GW, as the beacon antenna sits on top of the shack, and this is going to present a few cross-mod.

problems.

G8CLK is Ken Woollven of Aldershot, Hants, and to him goes Certificate No. 179. He is another HW-17A user, and runs this into an 8-ele. Yagi at 30ft. which also feeds the fet pre-amp, Nuvistor converter and a CR-100 Rx. He gets nearly 60% QSL return rate, and finds that the Class "B" operators are better at replying than the others. His 70 cm. rig is almost complete, and he hopes to take the Morse test later this year.

The Rectory in Poplar, London is the QTH from which Bob Royall, G8EBP/G4BOW gains Award No. 180. He runs 50 watts input to a '320A on 2m. and this feeds an 8-ele. Yagi at 50ft. rotated by a cowl gill motor. For reception he has a G8AEV converter and the Hammarlund HQ-170.

Double Top this month goes to G8EOP, Melvyn Jackson (Dewsbury, Yorks.) who claims both the 2m. and 70 cm. Awards—and gets them! Nos. 181 and 16 respectively. Initially, the 2m. gear consisted of a QQVO3-10 with 15 watts input and a home-built converter to a CR-100, but this has now been changed for 50 watts output with a mixer VFO, a pre-amp and a *Microwave Modules* converter to an Eddystone 888A. The 10-ele. beam at 35ft. remains unchanged. On 70 cm., Melvyn started with 25 watts input to a 320A tripler but now runs 90 watts input to a '640A. For reception he uses an AF239 pre-amp with another *M.M.* converter into the 888A. The beam is a 46-ele. job at 40ft. First licensed in February, 1971 he was QRV on the two bands without any delay.

A feature of these VHFCC Awards is the large number of G8/3's who claim compared with the small number of Class "A" claims, in spite of the fact that, with CW at their disposal, it should be easier for them to make the requisite number of contacts. Perhaps they have done it all before? Or perhaps we should publish the rules again? So, here they are. Your claims should be made for 100 contacts with different stations completed on one of the VHF bands (4m., 2m. or 70 cm.) from a fixed QTH, and which are supported by QSL cards. The lists, which should show the callsign and the date of the contact, should

include a description of your station and be sent to "VHF Bands", SHORT WAVE MAGAZINE, BUCKINGHAM.

### SSB in GM

SSB in Scotland, as in other parts of the country, has been given a lift by the number of "Liner-2" rigs now on the air, notably that operated by GM3SAN/P who seems to be laying down a respectable signal over much of Fife and the Lothians. How about getting some of them up on Oscar? Regulars are: GM6XI, GM6XW, GM3FGJ, GM3PQU, GM3BQA, GM8BJF, GM8DIJ, GM3SAN, GM3KXM and GM3ZVL among others. All good stuff, and likely to lead to more GM/G DX contacts during the coming months. GM3GUI is reported to be just about ready to go with an FL-500 and a transverter. His station was recently in the path of a 100 m.p.h. gale which bent his 3in. steel tube mast over at right angles! Sandy Lawrie, GM3PQU, runs an FT-200 with HB transverter to a beam at 80ft. above a block of flats and is able to work GM3KJF in Ayr with nae' bother in spite of the difficult path. He plans to enter the Oscar stakes. GM3ZVL has now completed his solid-state transceiver for 2m. and although he only has 200 mW out to the 8/8 is getting very fine reports. He plans a varactor tripler to go with it for portable operations. His former schoolmaster, mentor and friend, GM3BCD, must be nodding his approval.

There seems to be no holding the "Laird of North Berwick". Not content with the Parabeam at 70ft., GM3BQA has added an 8/8 slot-fed beam at 80ft. to the aerial farm and, having acquired a transverter from

GM6XI, is now blocking front-ends over quite a large area with 2 watts of SSB. With the appearance in his shack of some 4CX250B's it does not need a Sherlock Holmes to divine his next move! How about Oscar, Jim?

GM8BJF has recently obtained a 9 MHz McCoy filter and is planning a rebuild, mostly solid-state, of his SSB rig, and the other Brian, GM8DIJ, already QRV with SSB on two metres, intends an onslaught on 70 cm.

### Portable Occasions

The School of Engineering Science, U.C.N.W., Bangor, will be operating portable in Denbigh during the 144/432 MHz contest over March 3/4. Site is 1,850ft. a.s.l. and they will have 50 watts of AM on 145.35 MHz and 100 watts p.e.p. on SSB into a 10/10. And 80 watts on 432.75 MHz into a 46/46 at 50ft. will also be available.

Phil Edwards, GW8FJK, will be on from Brecon each evening from 1930z onwards during the first two weeks of March. Rig is HW-17 and an 8 ele. Yagi. Skeds to: P. Edwards, 1 Matthew Terrace, Penrepiod, Pontypool, Mon., with s.a.e. He has been doing very well from the site recently, having worked a string of F's and a PA0 and heard two EA! He points out that not *all* GW's hibernate after VHF/NFD!

Queen's University Radio Club will be heard from the Mull of Galloway between 1800z on March 16 and midnight on the 19th. They will have 4m. and 2m. and will use the call signs GM3LLQ and GM8FQB. If anyone will twist their arms sufficiently, and will *guarantee* to keep a sked, they are prepared to take 2m. RTTY with them. An s.a.e. to GI3XGI, *QTHR*, will bring you the info.

The West Kent A.R.S. intend to be in Rutland during the March 2m/70 cm. contest. QRA ZM21d, 6 km. SW of Oakham. They have AM/CW/SSB on 2m. to an 8/8 phase fed antenna and AM on 70 cm. with a 46-ele. Yagi. The call sign on both bands will be G3WKS. Further details from G3YOU, *QTHR*.

The Swindon District Club will be operating as GW3FEC/P from their Foel Grach QTH in Snowdonia for all the major 2m. and 70 cm. contests during 1973. For VHF

/NFD they plan to have GW3ZVC/P on 432 and 1296 MHz and GW4BDW/P on 4m. from the same site. They also envisage a trip to Arran over July 7/8 with 400 watts p.e.p. SSB and 150 watts of AM and CW to a 14-ele. beam on two metres. It is interesting to record that they made contacts with 7 countries and 36 counties during the recent 2m. SSB event.

### Annual VHF Tables

A gratifying start to the new Tables so early in the year. Just to remind you how they work: They show claims for contacts made from permanent locations between January 1, 1973, and December 31, '73. From time to time, the composite Table will be broken down into bands to show results separately on 4m., 2m. and 70 cm. in descending numerical order. Your claims should be sent to: "VHF Bands", SHORT WAVE MAGAZINE, BUCKINGHAM. The initial claim should consist of a list of counties and countries worked, with call signs and dates, and thereafter monthly *additions* should be submitted giving similar details, and also *the new totals claimed*, the latter to provide a cross-check. The leading station overall at the end of the year will receive a free subscription to SHORT WAVE MAGAZINE for one year.

It is regretted that the final 4m. Table for 1972 had to be omitted from the last issue, but space considerations did not permit its inclusion.

### News Items

SSB: G3XDY (Cleethorpes) is now on 2m. SSB and puts in a plea for the allocation of a band of frequencies for that mode rather than the present arrangement of a single calling channel and a spread-out from there. The increase in SSB operation would certainly seem to justify such a move, and a 100 kHz sub-band would just about fit the case, judging by the traffic during the last contest, and the vast increase in this mode of operation following the introduction to this country of the ubiquitous "Liner-2". It would also help to resolve the AM/FM-on-SSB-calling-channel problem.

Discussing SSB, G3BW of Cumberland is enchanted with the mode and the DX it brings. He quotes F6BCK causing QRM to GW3NNF

### THREE BAND ANNUAL VHF TABLES

January to December, 1972

#### FOUR METRES

Station	Counties	Countries	Total
G5DF	52	6	58
G3OHH	51	6	57
G3ZMD	37	4	41
GD2HDZ	34	4	38
G3DAH	34	2	36
G2AXI	31	3	34
G3EKP	23	6	29
G3FIJ	12	2	14
G3PQF	5	1	6
G3SMU	5	1	6
GW3CBY	3	1	4
G3YRH	2	1	3



## THREE BAND ANNUAL VHF TABLE

January to December, 1973

Station	FOUR METRES		TWO METRES		70 CENTIMETRES		TOTAL Points
	Counties	Countries	Counties	Countries	Counties	Countries	
GD2HDZ	3	1	36	5	8	2	55
G3DAH	7	1	36	6	2	1	53
G3NHE	—	—	34	6	7	1	48
G8FUI	—	—	34	4	6	1	45
G8EOP	—	—	13	2	20	2	37
G3BW	—	—	32	5	—	—	37
G3DXY	—	—	27	7	—	—	34
G4AJE	—	—	28	5	—	—	33
G3OHH	16	2	2	2	8	2	32
G4BKG	—	—	25	4	—	—	29
G3FIJ	7	1	13	1	6	1	29
G8DOT	—	—	20	3	—	—	23
G8CBU	—	—	17	2	3	1	23
G8DGR	—	—	11	1	6	1	19
G8BKR	—	—	13	2	2	1	18
GM3ZVB	—	—	15	3	—	—	18
G8GXE	—	—	12	1	—	—	13
G3EKP	4	2	2	1	2	2	13
G8GBV	—	—	11	1	—	—	12
G8GJB	—	—	10	1	—	—	11
GW8CGH	—	—	7	2	—	—	9
G8COG	—	—	2	2	—	—	4

as an example of its potency. By careful selection during the recent contest, he was able to amass a score of 62 contacts from his rather remote QTH which yielded nearly eleven points per contact! And that's a bit better than is usual with AM /FM!

GD2HDZ reports the advent of another SSB operator on the Island. This is GD3TNS who runs a "Liner-2" from Douglas, and who has been getting out well in spite of the rather poor conditions of late. His name is also Arthur—just to confuse the issue.

70 cm.: G4BKG (Tunbridge Wells) hopes to be up on 70 cm. shortly with a Multibeam at 55ft. from a good VHF QTH. G8GBV (Derby) is also just about ready to go on the band with 20 watts to a QV03-20A and a Multibeam. GD2HDZ has been finding 70 cm. a bit difficult recently. During one session of the

Cumulatives he was unable to raise a single station! G8DGR (Newbury, Berks.) derives his 70 cm. output from a tripler driven by an HW-17A. The unusual thing about this is that he uses the base/collector junction of a 2N3375 as a varactor and finds that he gets more output that way than if the 3375 were used as a normal transistor—and you don't need a power supply! Just the job if you have a pile of VHF transistors with blown base/emitter junctions!

#### General

Many operators are faced with the problem of QRM from very local stations, and this is the case with G8DOT in Tiptree, Essex, who has five other 2m. stations within a quarter of a mile of him! Their solution has been to QSY on to the frequency of the DX and call as soon as the QSO with the

neighbour has finished. This has been found to be the better solution rather than trying to operate at different ends of the band, apart from the fact that it called for out-of-Zone operation.

G8GXE is looking for 2m. skeds on Sunday mornings with Essex and Oxfordshire. The address is: Stag End, Farthing Green Lane, Stoke Poges, Bucks.

Congratulations to G2DQ, Harry Collin of Chelmsford, who this year celebrates the 50th Anniversary of his first licence.

The Gibraltar 4m. beacon, ZB2VHF, is again in operation. Frequency is 70.26 MHz with 20 watts to a beam directed to the North. It has already been heard in this country (on January 2) by G3MD (Wickford, Essex).

J-Beam, Ltd. have been appointed sole U.K. agents for *VHF Communications* and all subs. and orders for equipment should now be addressed to them.

#### Conventions and Meetings

Just a reminder that the 1973 VHF Convention is to be held at the usual venue, "The Winning Post" Hotel at Whitton, on April 7. Tickets are £2.25 for all day on Saturday, £2 for the dinner only, 50p for the Saturday lectures only and all for free on Sunday morning, when discussion groups will cover a variety of subjects.

The U.K. FM Group (London) will hold an FM Convention on February 24 at Brooklands Technical College, Weybridge, Surrey. The afternoon lecture session is followed by a buffet supper and AGM. Tickets and further details from G8CKT, *QTHR*.

All future meetings of the South East UHF/VHF Group are to be held in the Electronics Building, University of Kent, Canterbury. Meetings programmed at Wye College have been transferred thereto. The next meeting is on March 2 at 1930 hrs. when Dr. Dain Evans, G3RPE, will be talking about microwave techniques.

#### Deadline

Deadline for the next issue is March 9. The address for news, views and comment is: "VHF Bands", *SHORT WAVE MAGAZINE*, BUCKINGHAM. Cheers for now and *vy 73 de G3DAH*.

# THE MONTH WITH THE CLUBS

By "Club Secretary"

(Deadline for April issue: March 9)

(Please address all reports for this feature to "Club Secretary", SHORT WAVE MAGAZINE, Buckingham.)

THE story of Amateur Radio is one of Communication—at least, it *ought* to be! However, one wonders occasionally whether some of the newsletter compilers ever think of their task in these simple terms. For example, one Club who shall be nameless has a prize pessimist and groaner as its Newsletter producer and, to be fair, he does a grand job most of the time. However, he writes a regular preample, and *always* lays it on the line that the Club is "on the floor" for want of a bit of help from members at large for the hardworking committee men. They had to move to a cheaper Hq. because the members didn't come through with their subs—just two people undertook *all* the work for the Mobile Rally—and so on interminably, month after month. It's a marvel, after so much brainwashing, that they have any members left at all!

But this happens to a greater or lesser extent in lots of groups, who thus seem to go out of their way to give themselves a thoroughly bad image. If a prospective member sees one of those newsletters he is instantly *lost*—and that can't be the objective, can it?

The one hard remaining fact—and it ought to have been brought out in last month's Editorial—is that the progress and success of any Club depends primarily on a keen, hard-working and conscientious secretary, whose only interest is to make the Club "go". If yours is one such, cherish him dearly, for they are not thick on the ground.

## The North

A larger proportion than for some time past hail from Aurora Borealis country, if one takes into account that some more groups reported have found their way into the "Short Notices" section as their turn has come up.

**Mexborough** are, at the time being, still in the process of getting the programme knocked into shape for the rest of the year, although we do know that moves are being made to set up a permanent Club station with own call. For the rest, we have to refer you to G4BMJ, *see* Panel, who assures us the lads welcome visitors to their gatherings.

Another to make a point of offering visitors welcome is **York**, who are to be found in the British Legion Hq. at 61 Micklegate every Thursday evening.

Possibly the largest gain over a year ever to be brought to the notice of your conductor is that of **Spalding**, whose numbers have risen from 19 to 54! No wonder

the lads re-elected the existing committee *en bloc* at the recent AGM. You can find them at the Holland Teachers' Centre, Knight Street, Pinchbeck, on March 23; the start is at 7.30, to hear a talk on "Improving Your Receiver."

Every Wednesday members of the **Star** clan head for the New Inn Hotel, Bramley Town Street, Leeds—some by way of the transport which is laid on from City Square for members and visitors. The first Wednesday in the month is usually a Film Show, and the last Wednesday a Bingo Night with prizes pertaining to Amateur Radio. On the third Sunday, transport is available for some sort of outing. Details from G4BUU, as in Panel, p.42.

We see marks on the calendar against March 14 and 28, when we look at the **Grimsby** letter. March 14 is devoted to a talk on Fault-Finding, and the 28th sees them entertaining a lecturer. To find them, look for Grimsby Community Centre, Duncombe Street; the start is 8.0 p.m. on the specified evenings.

No doubt about the matter to be dealt with on March 22 by **Solway**—it's the AGM. It is understood the lads have weekly get-togethers at the Educational Settlement, Castle Hill, Maryport, to which they welcome visitors and potential members.

On Sunday, March 11, starting at 2 p.m., **Scunthorpe** have a Hamfest, with films to be shown, a special show for the distaff side, and tea laid on—also a licensed bar. The charge will be 50p. The venue for this Hamfest will be Grange Farm Hobbies Centre, Franklin Crescent, Scunthorpe.

The **Border** group also favour Sundays for their regular sessions; to be more precise the last Sunday in each month at 3 p.m., at the Tweed View Hotel, Berwick-on-Tweed.

It's all there, on the front page of the **Bury and Rossendale Newsletter**—the date, the venue, the Hon. Sec's name and address, the Lot! Good for them, making your scribe's job a bit easier. March 13 is down for a tape-and-slide lecture, at the George Hotel, Market Street, Bury.

Somebody has a lot of work to do at **West of Scotland** where the activities cover every Wednesday and Friday of each month. Basically, the pattern is that the Wednesdays—March 7, 14, 21, 28, are all down for VHF activity, constructional, and problem-shooting—while for Fridays, March 2, 9, 16, 23, 30, there are lectures, discussions, CW classes and similar activities.

The Cornish Amateur Radio Club, covering such a wide area with a large membership, is having to hive-off into groups for local centres of activity. Hence, the West Cornwall Radio Group has recently been formed for the Penzance district. Here we see G3ZPJ on the gear at the inaugural meeting, with (standing, right) G3UCQ—who for many years has been Cornish's hon. secretary—and G3HFS, local chairman of the new group.



For **Glenrothes**, we do not have a note of the Hq., for which we must refer you to GM3YOR—see Panel. However, we can say that the date to book is March 4, when GM3OXX will tell the story of his VHF portable expedition around the Scottish mountain peaks.

At **Hull** the Hq. in 592 Hessle Road is open each week—for March there is a talk on Aerials on the 2nd, a visit to Hull Power station on the 9th, G2ABR on Old Times should be interesting on the 16th, and the month is rounded off by a session on members' modifications to the Pye Sets.

#### Nationals

**A.R.M.S.** first; they cater for the /M interest, by way of various activities, an information service, their *Mobile News* and awards for mobile operating. The current month's issue contains a most interesting article on Aerials of a type giving low-angle radiation from hotel rooms, which at a pinch could be used by travellers—and anyway gives food for lots of thought!

As ever, **R.A.I.B.C.** look out for the invalid and blind in our Amateur Radio community, both listener and licensed. As a direct way of helping in the running of the group, any reader who has old copies of the international *Call Books* for disposal could well send them to G3LWY—see Panel—who could find eager recipients for them among her members. We also gather that their member John Moxham is trying to get an R.A.E. class organised in *Wells*—he has six takers but needs a minimum of eight to make the course a “goer.” Anyone interested please get in touch with John direct, at 40 Roman Way, Glastonbury, Somerset.

#### Midlands

And, oddly enough, we find **Midland** on the top of the clip. Their Hq. is at the Institute in Margaret Street, and here, on March 20, they will hear G3CNV talking about Raynet activities.

Nice it is to know of a Works Club prospering—which is what is happening at the **Joseph Lucas** group of factories in Birmingham, where the next meeting is as far ahead as April 10, in S4 Conference Room, Well Street, Hockley—all the important details can be obtained from G3GVN, address as Panel, p.42.

It is quite a while since last we heard of the **Wirral DX Association**, but we are assured they are very much alive and kicking. They meet in each other's homes on the last Thursday in the month, which means that any intending member should get in touch with G4AHC, see Panel, to clear the courtesies first. Visitors are certainly welcomed.

Mondays are VHF Nights at Greeba, Shady Lane, Manchester 23, and Fridays the main meetings of the **South Manchester** group at Sale Moor Community Centre, Norris Road. The programme for the latter is: March 2, G3FNM on “Safety in the Shack”; March 9, G8ENC and others, looking into the Pye Cambridge; March 16, a talk by the firm of *Microwave Modules*; March 23, the Club QRP transmitter project reviewed; and to wind up on March 30, a “mystery lecture” by G3HZM.

**Slade** is the name of a very old-established Midlands Club now based on Hq. at Church House, High Street, Erdington, Birmingham—Slade was one of the original amateur scientific societies. The lads can be found here

on March 9 and 23, the former date being for G3JZF to lead the inquest on VHF NFD, and the latter for an illustrated talk entitled "With a Camera in the Alps"—keeping to Slade's tradition of taking in everything of amateur scientific interest.

From where we sit, it looks like March 5 and March 17 for the Worcester chaps, although the copy of their *Newsletter* to hand does not extend thus far in advance. The venue, we understand, is the Shakespeare Hotel, Angel Street. Further details can doubtless be obtained by getting in touch with G8ASO—see Panel, below.

As usual, Coventry have a full programme for March. The 2nd is a film show; March 9 and 23 are to be Nights on the Air with the Club station; and March 16 a Space lecture. For venue, times and other details omitted by G3TFA, chase him at the address in the Panel! (Sorry, but we can't dream it up!).

### Westerns

The City of Belfast YMCA group celebrates its golden jubilee this year and to mark it, they are setting up

an award available to both transmitting amateurs and SWL's. For details of these and the Club activities, refer to GI3NQH, as Panel, hereunder.

Rhondda are also looking ahead, to April 26, when the RAFA Club, Treorchy, will be the scene of a social evening to which amateurs all over South Wales are invited. Club Secretaries with groups of members wishing to attend are asked to give lists of names to the hon. secretary of the Rhondda Club by April 1. Tickets at £1.50 cover the dinner and the dancing later, and the bar will be open till 11.30 p.m.

One always likes to hear of a Club which has been in the doldrums climbing back to top form, and there seems little doubt that Hereford are in that category. The date of the next get-together, at the County Control, Civil Defence Headquarters, is March 2, but as the AGM is due about the time these words are going down on the typewriter, we cannot expect to give details of what will happen—however, we will bet they have something to offer!

Having successfully passed the thing called Extra-

### Names and Addresses of Club Secretaries reporting in this Issue:

ACTON, BRENTFORD & CHISWICK: W. G. Dyer, G3GEH, 188 Gunnersbury Avenue, Acton, London, W3-8LB.  
 A.R.M.S.: N. A. S. Fitch, G3FPK, 40 Eskdale Gardens, Purley, Surrey, CR2-1EZ.  
 BARKING: H. Davidson, G3FZP, 223 Salisbury Avenue, Barking, Essex.  
 BASINGSTOKE: R. H. Oakley, G8FKT, 81 Camrose Way, Basingstoke.  
 BEDFORD: J. Bennett, G3FWA, 47 Ibbett Close, Kenipston (2427), Bedford.  
 BISHOPS STORTFORD: E. P. Essery, G3KFE, 17 Ascot Close, Bishops Stortford (52501), Herts.  
 BORDER: C. H. Crook, G3YOG, 19 Hatters Lane, Berwick-on-Tweed.  
 BRIGHTON (Technical College): R. J. Henley, G2CMH, 35 Wilmington Way, Brighton, BN1-8JH.  
 BURY & ROSSENDALE: J. Clifford, G8DHT, 10 Arley Avenue, Bury, Lancs, BL9-5HD.  
 CHILTERN: M. Connell, 38 White Close, High Wycombe (31314), Bucks.  
 CITY OF BELFAST YMCA: J. Beattie, GI3NQH, 12 Wellington Place, Belfast, BT1-6GE.  
 CORNISH: H. Webster, G3XTF, Crandale, Gillyfields, Redruth (6905).  
 COVENTRY: G. Whenham, G3TFA, 33 Chapel Street, Bishops Itchington, Warks.  
 CRAWLEY: A. Davis, G3MGL, 41 Gainsborough Road, Tilgate, Crawley, RH10-5LD.  
 CRAY VALLEY: P. F. Vella, G3WVP, 78 Hurst Road, Sidcup.  
 DERBY (Nunshill House): I. Cage, G8BV, 25 Petersham Drive, Alvaston, Derby, DE2-0JU.  
 DUNSTABLE DOWNS: C. G. Powell, G8BPK, 1 Wenwell Close, Buckland Wharf, Aston Clinton (600), Aylesbury, Bucks.  
 ECHELDFORD: V. W. Higgs, G3VWJ, 205 Commercial Road, Stains, Middx., TW18-2QT.  
 EDGWARE: A. J. Masson, G3PSP, 62 Coldharbour Lane, Bushey, Herts., WD2-3NY. (01-950 6827.)  
 GLENROTHES: A. Givens, GM3YOR, 41 Veronica Crescent, Kirkcaldy, Fife, KY1-2LH.  
 GRIMSBY: W. E. King, G3WEK, 20 Welland Avenue, Grimsby.  
 HEREFORD: S. Jesson, 181 Kings Acre Road, Hereford.  
 HORSHAM: T. Wadsworth, G3NPF, 39 Church Road, Broadbridge Heath, Horsham, Sussex.  
 HULL: Mrs. M. Longson, 4 Chester Road, Wold Road, Hull, HU5-5QE.  
 LINCOLN: F. Day, 5 St. Marks Avenue, Cherry Willingham, Lincoln (51058), LN3-4LX.  
 LUCAS: J. H. Butt, G3GVN, 90 Mereside Way North, Olton, Solihull. (021-706 7992.)  
 MEDWAY: H. E. Willis, 11 Laburnum Road, Strood, ME2-2LB.  
 MEXBOROUGH: J. C. Rolley, G4BMJ, 143 Sheffield Road, Warmsworth, Doncaster.  
 MIDLAND: N. Gutteridge, G8BHE, 68 Max Road, Quinton, Birmingham 32. (02-422 9787.)

MID-SUSSEX: E. J. Letter, G3RXJ, 87 Meadow Lane, Burgess Hill (3552), Sussex.  
 NORTHERN HEIGHTS: A. Robinson, G3MDW, Candy Cabin, Ogden, Halifax (44329), Yorkshire.  
 NOTTINGHAM: S. F. Claringburn, 49 Fernleigh Avenue, Westdale Lane, Nottingham, NG3-6FN.  
 R.A.I.B.C.: Mrs. F. Woolley, G3LWY, Woodclose, Penselwood, Wincanton, Somerset.  
 READING: D. King, 34 Crawshaw Drive, Emmer Green, Reading, RG4-8SY.  
 REIGATE: F. H. Munday, G3XSZ, 2 Conifer Close, Reigate (43130), Surrey.  
 RHONDDA: C. M. Parry, GW3PHH, 34 Ca'er-Gwerlas, Tonyrefail, Porth, Glam.  
 SCARBOROUGH: J. Cutter, G3VAN, 124 Briercliffe, Scarborough.  
 SCUNTHORPE: R. Hotchin, G4ATA, 12 Cowper Avenue, Scunthorpe (67137), Lincs., DN17-1PB.  
 SHELBURNE (Youth Centre): F. C. Smith, Warden, Shelburne Youth Centre, Benwell Road, London, N.7.  
 SLADE: J. E. Drakeley, G8GRC, 186 Conway Road, Chelmsley Wood, Birmingham 37.  
 SOUTH BIRMINGHAM: R. Thompson, 23 Fox Hill, Selly Oak, Birmingham 29. (021-472 0533.)  
 SOUTHDOWN: A. Seabrook, G3ZQB, 6 Harebeating Gardens, Hailsham, BN27-1JT.  
 SOUTHGATE: J. Batchelor, G3XMV, 22 Faversham Avenue, Bush Hill Park, Enfield. (01-360 6537.)  
 SOUTH MANCHESTER: D. Holland, G3WFT, 7 Alcester Road, Sale, Cheshire, M33-3GW.  
 SPALDING: R. Harrison, G3VPR, 38 Park Avenue, Spalding, PE11-1QX.  
 SOLWAY: J. Hardingham, Woodbine Cottage, Dearham, Maryport.  
 STAR: T. Lecman, G4BUU, 115 Asket Drive, Searcroft, Leeds.  
 SUTTON & CHEAM: J. Korndorffer, G2DMR, 19 Park Road, Banstead.  
 THAMES VALLEY: C. B. Seaman, G3ATF, 40 Park Road, Ashford, Middx.  
 TORBAY: Mrs. G. Western, G3NQD, 10 Truro Avenue, Hele, Torquay.  
 VERULAM: H. Young, G3YHY, 93 Leaford Crescent, Watford, Herts., WD2-5JQ.  
 WEST KENT: H. Richards, 17 Reynolds Lane, Tunbridge Wells.  
 WEST OF SCOTLAND: M. Parks, 6 Stamperland Hill, Clarkston, Glasgow, G76-8AE. (041-644 1783.)  
 WIRRAL (DX Association): T. O'Neill, G4AHC, 41 Willoughby Road, Wallasey, L44-3DZ.  
 WORCESTER: B. A. Jones, G8ASO, 12 Woodside Road, Larkhill, Worcester (29208).  
 WORTHING: G. Hooper, G8ETL, 12 Bramble Crescent, Durrington, Worthing (62013).  
 YORK: K. R. Cass, G3WVO, 4 Heworth Village, York.

This picture is of the Glenrothes Amateur Radio Club, who came first for Scotland and 6th overall in the last MCC, signing GM3FXM/A. Callsigns identified here are GM's '3YBQ, '4BFQ, '3OLK, '4AOO, '3YOR (back row, right, hon. secretary and a well-known Top Band operator) and seated front l. to r. GM3ZAP, GM3PFQ, GM3FXM and GM4ALK.



ordinary General Meeting in January, **Cornish** are forging ahead. For the meeting booked at the SWEB Room, Pool, Camborne, on March 1, the main gathering will hear a talk by G3THT on the activities and doings of the Newquay group—who can be found at Treviglas School, Newquay on alternate Wednesdays. We also hear that a Penzance group is in formation—and we would think that old friend Bob Albright, G2JL, would have something to do with that.

#### South and East

First we have a note of a proposal for a new formation, at Shelburne Youth Centre, Benwell Road, London, N.7. Anyone interested apply to The Warden. One has to admit to a sense of surprise at such a Club proposal, almost on the Grafton doorstep, but nonetheless we wish them every success.

**Barking** have moved to new Hq. at Westbury Recreation Centre, Ripple Road, where they meet every Thursday evening with, in addition, a Tuesday evening Morse class. Among the highlights of the coming month is a talk by G3GJW.

Chineham House, Popley, is the location for the **Basinstoke** group, where they can be found on the first and third Saturdays in each month. The former date, for March, will be **Beginners' Night** and a talk on Station Operation, and the latter is for G3JHM to come along to talk about—and, doubtless, demonstrate—VHF equipments.

A double bill appears on March 1 at **Cray Valley**, where G3WVP will discuss the impact of VAT on we radio amateurs, followed by a group of members who will hold forth on Contest Operating Procedures. Then on March 15, there will be the usual Natter Nite—both these gatherings at the Church Hall, Court Road, Eltham, London, S.E.9.

**Horsham** have March 6 at the Guide Hall, Denne Road for G3WPO to talk about aspects of receiver design. In addition, there is the informal at the "Star" in Roffey; both meetings start at 8.0 p.m.

Unfortunately, the **Southdown Newsletter**, although it mentions the Victoria Hotel as the venue, has nothing in the way of dates given. This being the case, we can only indicate the Hq. is in Eastbourne area, and for the rest refer you to G3ZQB, address as Panel, opposite.

We are also a bit up against it over the **Medway** report. This says the lads foregather every Friday but omits to say where exactly. Once again, the answer is to contact the hon. secretary, as Panel.

March 6 at 8.0 p.m. should be of great interest to **Reigate**—G8AMU is to give an illustrated talk on his recent holiday in Russia, at the new meeting place, Church Hall, Birkenhead Road, to inaugurate this new venue. Ladies are invited. Informals are taken on the third Tuesday in each month, at the "Marquess of Granby," Redhill, in the saloon bar.

A definite change of venue for the **Thames Valley** lads, who have, for the March and succeeding meetings, moved into the small hall, St. George's Halls, Esher, where there will be all the conveniences. The next date, the first one at the new place, is March 7, but at the time of their letter the programme was not finalised.

At **Bishops Stortford**, the March get-together is on the 19th, for G3VVS to talk about and, hopefully, demonstrate Spectrum Analysis. This one is in the British Legion Club, Windhill.

**West Kent** have a couple of dates at the Arts Centre, Monson Road, Tunbridge Wells, on March 2 and 19. The earlier date is down for a talk about a digital calendar clock, while on the 16th there will be a visit by K.W. Electronics.

There is not much dead time in the **Worthing** syllabus with weekly meetings coming up at the Rose Wilmot Centre, Littlehampton Road, Worthing; March 6 is a report on the VHF/UHF contest activity, and March 13 an SSB demonstration. A Ragchew on March 20 is followed up by an evening on the Club project on the 27th.

The Staff canteen at Youngmans, Ltd., on March 7 will be the scene of the Junk Sale for **Crawley**, kickoff at 7.45 p.m. Back to the normal Hq. at the Church Hall, Ifield, Crawley, on March 28, when there will be a Constructional Contest and film show.

The **Dunstable Downs** group go from strength to strength—119 members and friends sat down to the recent dinner. They can be found on any Friday at Chews House, 77 High Street South, Dunstable, between 8.0 and 10.0 p.m.

The Ernest Turner works, Totteridge Avenue, High Wycombe, is the home of the **Chiltern** lads. March 13 is

## SHORT CLUB NOTICES

CLUB NAME	HEADQUARTERS LOCATION	MEETING MONTHLY
Acton, Brentford & Chiswick	66 High Road, Chiswick	March 20
Bedford	"The Dolphin," The Broadway	March 1, 8, 15, 22, 29
Crystal Palace	Emmanuel Church Hall, Barry Road, S.E.22	March 17
Derby (Nunsfield House)	Nunsfield House, Boulton Lane, Alvaston	March 4, 9, 16, 23, 30
Edgware	145 Orange Hill Road	March 8, 22
Lincoln	Lincoln Astronomical Society, Westcliffe Street	March 7, 14, 21, 28
Northern Heights	Peat Pitts Inn, Ogden	March 14, 21, 28
Nottingham	Woodthorpe House, Mansfield Road	March 1, 8, 15, 22, 29
Reading	White Horse, Emmer Green	March 13, 27
Scarborough	Technical College, Scalby Road (Lecture Room)	March 2, 9, 16, 23, 30
South Birmingham	Hampstead House, Fairfax Road, West Heath	March 7
Southgate	C.D. Hut, Bowes Road	March 8
Torbay	Bath Lane (rear 94 Belgrave Road.), Torquay	March 31

N.B.—In each case the Secretary's name and address appears in the Panel on p.42.

an informal; the programme for March 28 is not yet announced.

**Brighton Technical College** is in Richmond Terrace and there on March 3, the Club station, G3TCB, will be on the air, at an open meeting in Room B.7. March 19 should be interesting to the CW types as G3YY will be talking about his experiences with foreign Morse codes.

Amateur TV comes up for discussion on March 12 at **Echelford**, with G6AHO/T doing the talking. On March 29 there comes the all-important Annual General Meeting. However, the venue is not mentioned, and for that we have to refer you to the hon. secretary—see Panel p.42.

At **Shefford** the weekly sessions are held in the Church Hall, Amphil Road, every Thursday. G8AEL has March 1, for a demonstration of RTTY; on the 8th comes a session on workshop practice, with circuit diagrams and layouts; March 15 is for an out-of-the-way topic, namely G8DUY talking about Maps and the Radio Amateur. The R.A.E. Q. and A. evening comes up on March 22, and on the 29th, G3VMI tackles Phone and CW operating procedures.

The third Tuesday in every month is the routine for **Sutton and Cheam**; and they are to be congratulated on making sure they get their information out on time. This means we can say, with no "scratching around", that the March 20 meeting is a Surplus Equipment Sale and that it is to take place at "The Harrow," Cheam.

Once in a while we seem to get out of phase with **Mid-Sussex**—their current *Newsletter* does not carry the needed information for March, so we have to refer you to Panel. The Hq. is at Marle Place, Leylands Road, Burgess Hill.

March 21 is the date to book if you want to visit the **Verulam** lads, who are, for the moment, using the Market Hall, St. Albans, which is near Town Hall, in the Market Place. The time is 7.30 for an 8.0 p.m. start.

## Closing Date

For the next issue is **March 9**, addressed "Club Secretary", **SHORT WAVE MAGAZINE**, BUCKINGHAM. Dates forward to catch this feature are *April 6* and *May 4*—and we do mean to catch this feature.

Much regret that too-late reports were received from Cheltenham, Kingston, Solihull and Surrey Radio Contact—in order of opening after last month's deadline. We just cannot take in late reports after the feature has been composed for the printers.

When the London FM Group held a two-metre "fox hunt" on Esher Common recently, ten teams set out to find G8AMG hidden in a wood near Ashted, Surrey. The object was to train members in VHF D/F. Some of the results seemed a bit odd to those who did not succeed in finding fox-G8AMG—the spread in terms of distance travelled was ten to 28 miles. Here we see the scene at the start, with G8CKT explaining the rules.



• • • **SWL** • • •

SHORT WAVE LISTENER  
FEATURE

By *Justin Cooper*

POINTS OF INTEREST FROM A HEAVY MAIL  
— QUERIES AND THEIR ANSWERS — NEWS  
AND COMMENT — ANNUAL HPX LADDER  
CLOSES, AND OPENS FOR 1973

THE subject of aerals and planning permission is one that often seems shrouded in mist and uncertainty; what is the only solution to be acceptable to one council is the only unacceptable one to another. Many SWL's—and indeed many licensed types—make do with far less than the minimum standard of aerial merely to avoid conflict with the authorities.

There is much which can be done with thin wire, particularly by receiving set-ups, over and above the simple end-on arrangement fed against an "earth" consisting of a couple of two-foot stakes knocked into the soil coupled to the receiver through a bit of 22g. wire. For example, beam arrays do not *have* to be rotatable; they can do much good by being fixed for a period of time and aimed at an area of interest. As an example, for long enough, J.C. has had a ten-metre beam comprising a folded dipole and a director aimed on U.S.A. and Central America, up in the loft. Recently, this was removed and replaced by another beam for 21 MHz, this time aimed on Africa, also in the loft—this one is a bit long in the elements to be fitted in the loft, so the ends have been turned down vertically and symmetrically. It shows appreciable gain in the desired direction, as compared with a simple dipole.

**HPX Ladders**

This month sees the last showing of the 1972 Table. Our congratulations to *N. Gerdes (Basingstoke)* on emerging as the leader on this occasion. All scores made should be recorded somewhere for later use in the *All-Time Post War Table*. Next time we begin all over again, as from January 1st, 1973, with the usual requirement to hear at least 200 prefixes to make a start on the Table. Let battle commence!

**The Letters**

*W. B. Taunton (Meopham)* says his Echo 8G aerial is in fact at ground level. However, the main thing is clearly that it *works!*—and, at that, without offending the eye of the neighbours.

Quite a few people have queried various IV5 call-signs; they have all originated from Viareggio (North-West Italy) in connection with some special-event activity. This answers the first question from *P. Barker (Sunderland)*; his second is about M1B, the M1 prefix being shown as unofficial in the Prefix List. A good point this—in fact, as far as the writer is aware, the M1 calls are quite OK in that they are duly allocated by the San Marino authorities, who do not use, for some reason

of their own, the ITU-allocated prefix of 9A.

*N. Callaghan (Cardiff)* has his nose right down to the grindstone, with his O-Level preliminaries on top of him, so he has to be content with a brief note and two more prefixes.

A much more unusual reason for inactivity is given by *J. Woods (Woodbridge)*, who has occupied his time making a sixty-foot, tilt-over, crank-up tower which works just like the book said—*good!*

*M. North (Bath)* has the best possible news—he passed the R.A.E., for which our congratulations. As for Morse, he has it at 10's at the moment, so practice will soon bring its own reward. On the debit side, the receiver is suffering from hiccups on Fifteen although all is well on other bands. Apart from telling it to hold its breath we don't really know what to suggest, although, since the fault *must* lie in the few components which are only involved for 21 MHz, it shouldn't take too much finding.

On to *S. Noakes (Cranbrook)* who claims to be quite content to be an SWL, and has some sensible comments on the place of the SWL in Amateur Radio—even if its just to phone some local who is calling CQ and getting nowhere, to let him know that at least he is getting out!

As often remarked, there are so many different interests within the broad definition of Amateur Radio that it is often difficult to advise the novice about, for example, equipment. This is brought home by the letter from *S. Scott (Stockport)* who has slithered from VHF right down to Top Band in his interests, leaving on the way a half-built DL6SW converter.

The *Bingham* boys, Dad, Billy and Joe, of *Carrickfergus* have split up the work in a different manner, to make life easier for Dad, we suspect! Be that as it may,

**ANNUAL HPX LADDER**

(Started January 1, 1972)

SWL	PREFIXES	SWL	PREFIXES
PHONE ONLY		PHONE ONLY	
N. Gerdes (Basingstoke)	458	W. McFaul (Londonderry)	310
P. Barker (Sunderland)	446	R. Griffiths (Ventnor)	301
R. Smye (Parkgate)	430	M. J. Stringer	
P. Newman (Thame)	428	(Southend-on-Sea)	300
R. Philpot (Shenfield)	411	A. Milner (Grantham)	270
D. Churchill (Bexleyheath)	405	C. L. Lee (Ilford)	266
P. Jerromes (Newton Abbot)	398	R. H. McVey	
B. Stone (Penzance)	385	(Weston-super-Mare)	262
Mrs. R. Smith (Nuneaton)	380	K. Williams (Swinton)	251
D. Harris (Telford)	372	R. Sharpe (Orpington)	247
R. F. McLeod (Glasgow)	372	W. Stallard (Cardiff)	241
G. Collins (Skegness)	357	S. Hurst (Sheffield)	237
K. M. Rogers (Ullesthorpe)	347	S. Scott (Stockport)	235
W. J. Smith (Benfleet)	311	N. Callaghan (Cardiff)	215

Above is last showing of the Annual for 1972. New Table opened w.e.f. January 1st 1973, first appearance to be in May issue. Starting score, 200 prefixes to be already logged since 1st Jan. before claiming. Rules as for HPX, see p.420, September 1972 issue.

they have dug up 53 new ones to bring them much nearer the top of the Table, although we have to doubt the "SY1MA" they logged, at a time when the real SY1MA was not there.

An interesting experiment is going on at the QTH of *M. Stringer* (Southend) who uses a Cubical Quad on 144 MHz. Your J.C. has always felt that the performance of the Quad in terms of side-lobes should be better than a normal Yagi, although VHF buffs often say differently—we must wait and see how the experiments pan out.

As always, *H. Alford* of Burnham-on-Sea (whose picture appeared on p.555, November) has points of interest in his letter. This time there are two; one on the lack of home-construction effort among the SWL's of today; he does not agree that there is any shortage of components (the usual reason given for buying) but rather a matter of pure laziness. He might be right at that! His other points concerns the unpredictability of the bands—for example, one morning he switched on to 21 MHz at 0940z, with ideas of logging the odd JA or two. In the event there were none, but as consolation there were VK4KW (working DU2EL) ZL3 and XWS, all quite readable. The interesting bit is that an hour later, the band was dead to all but Europeans.

Another point crops up in the letter from *G. Thompson* (Birmingham) who stresses the need for knowing when and where to look for your DX, as for instance the almost daily appearance of the VK/ZL stations in the mornings. On a different tack, he has an 8-ele. Yagi, sitting only two inches above the garage roof, and eight feet above ground, which has produced its fair share of DX—clearly said roof is not metallic!

*J. Cowan* (Rochford) presses on with his commercial radio-operator course, which takes up all his spare time as well; but when it is safely in the bag, John intends to have a bash at R.A.E., and come on Fifteen SSB, for which he wants a cheap transmitter—easy, build one!

\* \* \*

Those O-Levels! *L. Tarassenko* (Dorchester) has no less than eleven of the brutes in the way of his SWL'ing and R.A.E. studies. As if that were not enough, remains the problem, in the license context, that he is not yet a British citizen. On the brighter side, our correspondent is one of the few home-constructors about these days; he has his receiver finished and working on Eighty, to his satisfaction, and next step is to get it going on the other bands—a W3DZZ trap aerial is going up soon to help with the good work; and with any luck, by next time there will be an entry to put in to HPX.

Thirteen or not, and one of our youngest SWL's, *M. Peters* (Newbury) has his ideas sorted out on Prefixes, although he is bothered a bit by "9H5," as indeed are one or two others. It is quite genuine, and covers British Forces in Malta.

Shift work interferes with the listening of *W. Wellington* (Whitley Bay), who has a Trio 9R-59DS for general-coverage, and G3KGN's front-end and IF/AF strip as written-up in the SHORT WAVE MAGAZINE, September 1957 and May 1958, for amateur-band coverage; this Rx was built originally by G3FPE, who is R.A.E.-course king at Gosforth. SWL Wellington has had one go at R.A.E. and come unstuck, and is still trying, whenever

the XYL relents over the paint-pots. We know the feeling!

Anyone know anything about the R.1481? If you do, you might share your information with *R. Leslie* (Bridge of Weir) who has one and wonders what he can do with it. Write to him direct at Windyridge, Kilborchan Road, Bridge of Weir, Renfrewshire.

Once again *K. Kyezor* (Perivale) is about to be sent into the wilds where receivers are an unheard-of luxury; he has organised things so that an adequacy of letters containing "nil" reports arrive *chez* J.C. to keep him in the Table—good show.

*T. Vale* (Abingdon) has a KW-202, ATU to suit, TA32 at 28 feet, and a long-wire running NNE/SSW. He thoroughly recommends the KW receiver which has bumped up the DX heard quite considerably. One query was a station working VK3NR and giving just "9LC" as the call. Probably he was VK9LC if the truth were known, but we must regard him as doubtful on the evidence presented.

*E. Paterson* (Pinner) has been off SWL'ing for quite a while now, but has just returned to the game by way of a Heath GR-78, after a sickening series of mishaps had confused the issue for quite a while.

Life is real, life is earnest, says *A. West* (Herne Hill) because his 144 MHz converter switches itself on

## HPX LADDER

(All-Time Post War)

SWL	PREFIXES	SWL	PREFIXES
PHONE ONLY		PHONE ONLY	
R. Shilcock (Lye)	1320	R. Pullen (Crawley)	720
S. Foster (Lincoln)	1301	A. R. Holland (Malvern)	712
T. Rootsey (Ilford)	1242	E. Parker (Hove)	706
A. W. Nielson (Glasgow)	1131	W. B. Taunton (Meopham)	703
J. Fitzgerald		C. K. Verstage (Old Basing)	671
(Gt. Missenden)	1107	C. Lancaster (N. Ferriby)	671
K. Kyezor (Perivale)	1082	S. Wessely (Sheffield)	669
W. Bingham		B. Thomas (Pontefract)	668
(Carrickfergus)	1053	D. A. Shepherd	
W. Edwards (Tadworth)	976	(Brierley Hill)	651
I. Brown (Newtownabbey)	972	A. West (Herne Hill)	644
R. Carter (Blackburn)	957	A. Judge (Bishops Cleeve)	641
A. Mercer (Wigan)	922	O. L. Cross (Bexleyheath)	614
H. Alford (Burnham-on-Sea)	917	J. Woods (Chillesford)	606
M. J. Quintin		L. Thomas (Castleford)	604
(Wotton-u-Edge)	912	M. Cuckoo (Herne Bay)	586
B. Hughes (Worcester)	877	J. R. Cowan (Rochford)	578
D. Rodgers (Bolton)	863	K. C. Webb (Reaching)	571
N. Askew (Coventry)	821	H. Stephenson	
K. Plumridge		(Newcastle-on-Tyne)	569
(Southampton)	820	M. North (Bath)	530
N. Hembrey (Northiam)	818	M. Kitchener (Hitchin)	523
J. H. Sparkes (Trowbridge)	816	CW ONLY	
S. Proud (Letterston)	814	A. Glass (Plymouth)	896
G. W. Raven		G. Proud (Letterston)	666
(London, S.E.13)	791	T. Rootsey (Ilford)	652
M. Fisher (Bradford)	779	W. B. Taunton (Meopham)	600
P. L. King (Emsworth)	775	A. Rowland (BFPO 53)	438
L. A. S. Poole		D. Rodgers (Harwood)	388
(London, N.21)	774	R. Mortimore (Cardiff)	324
H. M. Graham (Harefield)	733	J. Whittington (Worthing)	316
M. Williams (Seaford)	727	J. Dunnett (Liege)	311
E. W. Robinson			
(Bury St. Edmunds)	721		

Starting Score 500 for Phone 200 for CW. Listings include only recent claims. Rules for HPX—see Panel, p.420, September 1972. DX Zone Map with latest Prefix List 85p post free (Prefix List alone 23p post free) from Publications Dept., Short Wave Magazine, 55 Victoria Street, London, SW1H-OHF.



and off at regular intervals. This sounds as though the converter has a stage that is squegging—if it worked OK before, and it is a valved device, you could do worse than go through the thing with a soldering-iron for dry joints or broken wires.

A change of receiver is reported by *H. Glass (Plymouth)* this time, Bert having now gone to a FR-DX400, which enables him to hear *Oscar VI* goings-on. So far, Oscar has stumped up with 27 countries, and four new prefixes, which is good listening.

*R. Shilcock (Lye)* mentions the “DX Information Net” on around 3780-3790 kHz at 2030 each evening as a useful source of gen. His HPX total shows no less than fifty increase—doubtless extra work undertaken to make sure of tipping *S. Foster* off his seat at the top of the Table!

Perhaps the understatement of the month comes from *W. Stallard (Cardiff)* who says he heard a “chap signing a GW9 and this seems strange to me.” (Strange to us, too!) Bill was lucky at Christmas, with a nice shiny 9R-59DS receiver, very much approved of.

Another one who has been shopping is *M. Cuckoo (Herne Bay)* who has come home with a Yaesu FR-DX400, but because of domestic chores has not really been able to exercise it much yet.

\* \* \*

During the compilation of this piece, the news broke across the country that the December R.A.E. results were through; one who was still waiting at the time of his letter was *K. Plumridge (Southampton)*, who was the more on edge as this was his fourth stab at it.

*K. Williams (Swinton)* comes in with a first entry; he uses a Trio 9R-59DS or an HR-10B, coupled to a PR30 Preselector, and a Joymatch ATU, the latter being fed from a TD-3Jr. trap dipole and a Joystick in parallel.

A prize combination of circumstances conspired to keep the total down for *R. Carter (Blackburn)*. For a start, conditions have not been marvellous on the bands anyway, as for example the Commonwealth Net had not been heard since before Christmas at his time of writing. On top of that, the BFO valve in the receiver expired—luckily a spare was found around the house—and to crown it all along came a “bug” and laid Ben low. No wonder the score is also a bit low!

*E. Parker (Hove)* wants to know how high we rate his chances in the R.A.E., at age 58—Ernie has already made a start once but was brought to a stop by illness. One would think it will be a bit tough going, but there is no reason at all why a pass should not be obtained at the first sitting—many readers have passed R.A.E. as prelude to a retirement hobby. (In fact, each year R.A.E. candidates are aged 17 to 70).

*R. H. McVey (Weston-super-Mare)* has the advantage that his father used to be G3GMC in 1955, and has decided to re-activate, starting with the purchase of an FR-50B receiver; a couple of thirty-foot masts are next in prospect, to have eighty feet of wire strung between them.

Another father-and-son team are the Smye family, of whom *R. Smye (Shrewsbury)* reports. The winter gales have done the big-stick an injury, reducing it to half its designed height. On the other side of the book, Dad has received his pass-slip for R.A.E., to their pleasure.



As the result of a road accident some years ago Brian Hartley, 23 Hastings Road, Thornton Cleveleys, Lancs. is confined to a wheel chair at the early age of 24 years—but he has a very fine SWL station as some consolation. It includes Yaesu FR-DX400, Collins 75S-3B and Drake R-4B receivers, with various two-metre Rx units and a Robot SS/TV monitor. Antennae are beams for 2-10-15-20m. on a tilt-over Versa-tower, with rotator unit, a 70ft. Tavasus whip for Top Band and a trapped inverted-Vee for 40-80m. The earth system involves about 200ft. of wire. He holds 18 listener awards, does all his own repair work and is going for the R.A.E. We wish him every possible success in Amateur Radio.

*W. J. Smith (Benfleet)* has taken the game up again after a lapse of 45 years, by way of a Zenith receiver given to him as a retirement present. The stimulus is such that active thoughts are being turned to R.A.E.—one thing is that, although rusty, his Morse has not been entirely lost and should therefore be of adequate standard by the time the R.A.E. pass is obtained. On a different tack, *W.J.S.* mentions that the 9C9 prefix hailed from EP-land, as a special to mark the anniversary of the “White Revolution.”

*V. Porter (Barnet)* has some points on the CQ and ITU Zone scheme. Basically, the CQ Zones are forty in number, divided up arbitrarily to make an interesting chase working them—for instance, Zone 23 comprises part China, Mongolia, Tibet, and a bit of UAØ, just to make things less easy. On the other hand the ITU Zone system was generated comparatively recently to enable data to be reduced to statistics which would aid in propagation and other such research, and is based on the ITU zone system for the administration of BC stations; thus it has no particular relevance to Amateur Radio. *Vernon* is one of the select band of SWL's who have been at the game for years without serious thought of a “ticket” and he has logged all 40 Zones—so in his retirement days he is going to leave the complexities of the ITU Zone scheme well alone.

A nice long letter from *R. C. Woolley (Ashbourne)* raises lots of questions about the business of getting started in the hobby. However, suffice it to say that *Richard* hopes to have a “proper” receiver working by the time this reaches print, always assuming he gets the

XYL's new kitchen finished first—we sympathise!

R. Pullen (Crawley) comments among other things on the local interest in using the FT-2F, and indicates that he may well follow the trend when he has passed the R.A.E. Talking about that, Ross says he has had quite a bit of help from his course tutors, and from his boss at work who is G3ZWS.

For what must be the first time ever, S. Foster (Lincoln) writes in to offer a nil-report, Stew having been pretty busy with other matters. This settles it, and means R. Shilvock passes Stew's total at the top of the Ladder. However, Stew has made his plans, and we wait to see how the battle will go!

\* \* \*

Quite a few points crop up in the letter from D. A. Shepherd (Kingswinford). First, he wants to know how to D/F some pirates on Top Band who are annoying his locals. What one wants is simply a portable receiver with an in-built ferrite rod aerial (which they mostly have, anyway) to tune Top Band. The null will be found to be along the line of the ferrite rod, and should be used in preference to the peak which is wider and made more so by the effect of AVC. Then take a series of shots from different points and plot them on a suitable map, in both directions since you have no "sense" arrangement. In the small area where your plots cross would be "the spot where the body was found." (In fact, this same technique can be used to pin-point almost any sort of QRM). The other question is drift with an 888 receiver. J.C. has one, admittedly not now in constant use, but it is fed from a constant-voltage transformer off the mains, which gets rid of mains-voltage effects on both heaters and HT lines.

A keen Top Band addict is A. Judge (Bishops Stortford) who for long complained of an "impossible" aerial for that band but now finds he has hooked such as KV4FZ and W1BB/1 on it. Tony has fifteen countries up, with "local" gaps such as 4U1ITU, OE and GC Jersey to be filled in yet.

Sad to say, for A. W. Nielson (Glasgow) the move to a new QTH has so far been a total disaster radio-wise. Until quite late in January, the receiver was not even plugged in, and when it was conditions were foul. Then he got 'flu, which was still holding him down at the time of writing.

A short list this time is explained by M. Williams (Sleaford) as being due to his pre-occupation with Eighty to the exclusion of DX on the other bands. However, although there has been plenty enough DX on Eighty of late Maurice has still not snagged a ZK1 to put in the log.

A long letter from H. M. Graham (Harefield) who seems to have been really "going to town" one way and another. First, there is the purchase of an FR-50B, then the move of it and the EC-10 to a new base of operations upstairs, in a room which has also to do duty as a store-room, spare bedroom, and darkroom when not used as a shack. However, all the apparatus seems to be "perking" in its new home. Hearing all the talk about Ten, Maurice has spent some time in monitoring the band during daylight at weekends, and over a period of several weeks there has always been something to be

found, usually in a North-South direction as is always the way on 10m. when the MUF is low.

Congratulations to R. Mortimore (Cardiff) who has his R.A.E. pass in the bag at the ripe old age of fifteen—and he did all the work for it by self-tuition, at that. The Morse test had been taken the day before his letter, (and, one would have guessed, passed, if his CW HPX score is a guide) so Richard expects to be able to tell us his call next time round.

G. Collins (Skegness) sent an entry in to HPX last time which would appear to have gone astray; which is our cue for rubbing home the need for accurate addressing, in a readable script. Such a simple error as writing, for example "Buckinghamshire", in place of Buckingham can make a whale of a difference—just compare the county with the town in either area or population, to see the point! To revert to Graham; he has a Trio 9R-59DS and an R.107, plus a 16ft. whip at 45 feet, and a long-wire round the garden. He has tried Two, using an FET converter, but without much success so far.

Wow! The pile of paper about half-an-inch thick wrapped in a letter signifies that P. L. King has rewritten his complete list since he got to Emsworth. What a task, checking a claim for 775 prefixes! However, it has to be admitted, it's a lot easier when done à la King, and nicely readable.

Lady Luck has been working overtime for him, avers R. F. Philpot (Shenfield). First, he made a straight swop of his HA-600 for a Trio JR-500S, and then he managed to get a good 18AVT/WB, second-hand but perfect, for £20, to the great benefit of the scores. All the existing gear, 9R59, ATU's, VHF converters and so on, are still in the shack and in use.

### Reporting

Last time out we had a letter from 9M2DQ on the subject of QSL's; this time another comes in from G3BHK, who is perhaps best known for his work in the Scout Jamboree-on-the-Air context. Les was involved with GB3BIC last year, and received 65 SWL reports. On his analysis, some of these optimists didn't even have the sense to mention in their "reports" such vital details as the date, the time or the band! Then there were others who had the cheek to send neither an s.a.e. or IRC, nor even a stamp, and yet almost demand a card!

Perhaps we should lay down some ground-rules for SWL reporting, along these lines: (a) Always make sure the report is being correctly addressed; it's not much use sending anyone a report direct, if he only QSL's via a manager, (b) Make sure your report has, as the very minimum, at least the date, the time, the mode of transmission, the frequency as accurately as you can read it, and the signal report at which you are hearing him. Again, a report is the more appreciated when the "target" is, for example, calling CQ with no reply—your report then tells him at least that his own gear is not at fault; (c) Send an s.a.e. or IRC—and for Pete's sake, don't forget that it's no good putting a U.K. stamp on an s.a.e. aimed at, say, a JY station; you have to go to the local stamp trader and get mint JY stamps of the appropriate value for your s.a.e. (this where the IRC comes in—you buy it at your local Post Office) whether for air or surface mail; (d) If you can possibly give a period-report over several operating sessions, do so;

and if any of his QSO's commented on his signal quality adversely, it will help if you, for example, can say that he sounded quite OK (or the other thing!) to you at the same point in time.

The letter from *J. Fitzgerald (Gt. Missenden)* looks back and forward. In the forwards direction one is pleased to note the odd CW logging, indicating that John is slowly working towards a pass in the Test; as for the backwards look, there is now a total of 153 countries all-time, logged on *Eighty*. And, note it you moaners about the QRM, most of them heard on an arrangement of two transistor portable sets!

*M. Cornwall (Harefield)*, on the other hand has found *Eighty* pretty uneventful of late, and has been tuning a Cossor portable radio down on to Top Band for a look there. Results have been quite reasonable so far. On the aerial front, great things are hoped for from the multiband trapped dipole arrangement soon to be put up.

Full of questions is *C. Verstage (Old Basing)*! First, Chris is looking for suggestions for a good aerial for *Eighty* and *Forty*—you could do worse, if you have the room, than use dipoles, as high as you can get them. *Where* to listen on *Eighty* and *Forty* for DX, next. *Eighty* SSB is all up at the 3795 kHz mark on the dial, but you will almost certainly find you can't hear it until you reduce RF gain considerably and run up the AF to compensate. As for *Forty*, it might be anywhere in the band, but again, reduction of RF gain is essential with most receivers. Last question is more technical—how far apart should four and two-metre beams be, mounted on a common mast? As far apart as possible, and both aerials pointing in the same direction.

How to you measure the input impedance of your receiver? So asks *D. Churchill (Bexleyheath)*. You don't—you look it up in the handbook! General-coverage receivers are often 400 ohms, amateur-only ones 50 or 75 ohms; but these are only normal and wander widely as you tune the bands. What is more important is

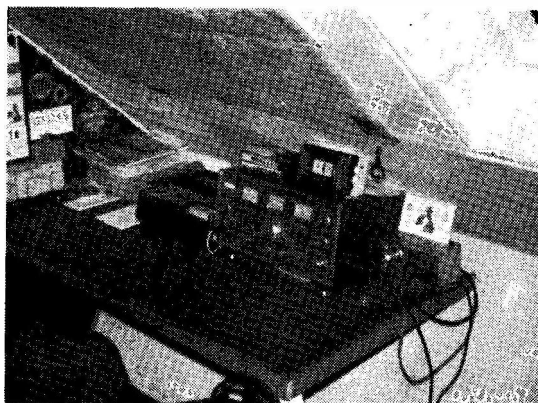

SWL Graham Armstrong, Harestones, Ancrum, Jedburgh Renfrewshire, Scotland is a 160-metre specialist, for which he has a Trio 9R-59DS and 550ft. of wire out at 50ft. up—also a 220ft. aerial and a 14ft. roof whip. At one time interested in the HF bands, he has altogether abandoned them and is learning CW to catch the 160-metre DX.

to tune out the reactance presented to the receiver by the aerial. The practical approach is to knock up an ATU and to fiddle with it till one gets the best signal-transfer—best S-meter reading—on a particular band, using a signal in ground-wave range as one's reference. This should take care of all the variables, and you can have it going quicker than you can do the sums.

#### Conclusion

That's it, once again. For the next piece, the deadline will be more like normal, to arrive first post on **March 22**, addressed "SWL," SHORT WAVE MAGAZINE, BUCKINGHAM. And don't forget, we're getting into the DX season, so things should be humming!

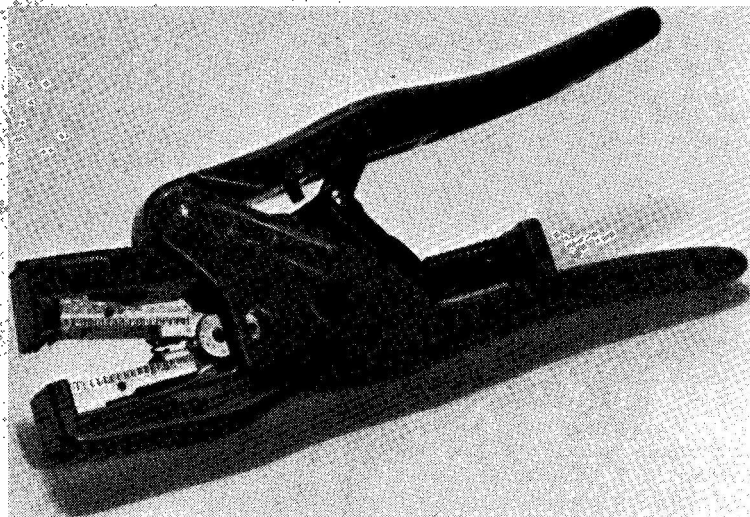

This fearsome looking tool is actually a highly efficient self-adjusting wire stripper, capable of dealing with stranded or solid, aluminium or copper, round or flat, single or multiple wires over a wide range of gauges, in one operation. Self-adjustment is over .01 to 0.1in. diameter overall, with a maximum capacity of 7/.02). It weighs only 8½ ozs. and is a product of Electroplan, Ltd., Royston, Herts., priced at £9.25.

# NEW QTH's

This space is available for the publication of the addresses of all holders of new U.K. call signs, as issued or changes of address of transmitters already licensed. All addresses published here will be reprinted in the U.K. section of the "RADIO AMATEUR CALL BOOK" in preparation. QTH's are inserted as they are received, up to the limit of the space allowance each month. Please write clearly and address on a separate slip to QTH Section.

**EI3R**, T. A. Hurley, 47 Lower Newtown, Waterford.

**G3YCC**, F. W. Lee, 8 Westland Road, Kirkella, Hull, Yorkshire, HU10 7PJ.

**G4BMT**, K. G. Long, Y.W.C.A., Fourth Avenue, Harlow Essex, CM20 1DZ.

**G4BOB**, A. H. Wallwork (*ex-G8ECV*), 9 Bury Lane, Withnell, Chorley, Lancs.

**G4BON**, B. A. Strutt (*ex-G8EKV*), 98 Fairview Road, Penn, Wolverhampton, Staffs., WV4 4TE.

**G4BPR**, P. H. Truran (*ex-G8DYS*), 125 Gospatrick Road, Tottenham, London, N17 7JD.

**G4BPU**, P. I. Fox (*ex-G8FKG*), 193 Conway Avenue, Great Wakering, Essex, SS3 0BL.

**G4BPY**, G. M. Pheasant (*ex-G8FDV*), 43 Station Road, Great Wyrley, Walsall, Staffs., WS6 6LH.

**GM4BQD**, R. N. Muir, 23 Aitken Drive, Whitburn, Bathgate, West Lothian, EH47 0HD.

**G4BQJ**, A. E. Hill, 3 Cambrai Avenue, Warrington, Lancs., WA4 6QU.

**G4BQK**, The East Riding Amateur Radio Group, c/o F. W. Lee, 8 Westland Road, Kirkella, Hull, Yorkshire, HU10 7PJ.

**G4BQM**, D. Daunt, 18 Grasmere Terrace, Murton, Seaham, Co. Durham.

**G8FLS**, I. W. M. MacIver, 165 Manchester Road, Accrington, Lancs. (*Tel. Accrington 32726*).

**G8GGL**, D. Havelock, 40 Danes Way, Leighton Buzzard, Beds., LU7 8LS.

**G8GMA**, D. Elliott, 56 Lincoln Avenue, Willenhall, Staffs., WV13 1JQ.

**G8GNX**, J. B. Bartholomew, 6 Addiscombe Avenue, Croydon, Surrey.

**G8GOP**, C. Pearce, 85 Percy Road, Hampton, Middlesex.

**G8GQK**, C. W. E. Sweet, 101 Renown Street, Keyham, Plymouth, Devon, PL2 2DD.

**G8GSO**, P. J. Atkins, Elm Cottage, Garston Hill, Chickerell, Weymouth, Dorset.

**G8GUT**, H. Richards, 43 Cowling Lane, Leyland, Preston, Lancs.

**G8GXA**, R. C. Vincent, 30 Rodney Crescent, Hoddesdon, Herts, EN11 9EW. (*Tel. Hoddesdon 64285*.)

**G8GXX**, N. S. Hoult, 34 Beacon Road, Loughborough, Leics., LE11 2BQ.

**G8GXX/A**, N. S. Hoult, Jesus College, Cambridge, CB5 8BL.

## CHANGE OF ADDRESS

**G2CIW**, J. F. Moseley, 3 Kit Hill Avenue, Walderslade, Chatham, Kent.

**G3AIU**, K. A. H. Rogers, Peartree Cottage, High Road, Essendon, Herts. (*Tel. Essendon 251*.)

**G3DNO**, A. E. Machin, Valleyside, Millthorpe Lane, Holmesfield, Sheffield, S18 5SA.

**GM3EOJ**, C. F. Sherrit, 17 Inchbrae Drive, Aberdeen, AB1 7AB.

**G3GDJ**, R. B. Wilson, 81 Clarence Road, Derby, DE3 6LR.

**G3IYT**, S. R. Walker, 11 Clee Crescent, Old Clee, Grimsby, Lincs.

**G3JKR**, K. S. J. Rancombe, 6 Park Drive, Rustington, Sussex. (*Tel. Rustington 4680*.)

**G1BKDS**, W. J. Woodside, 11 Lenamore Park, Lisburn, Co. Antrim.

**G3KWW**, R. W. Wilkinson, Lower Stonehams, Pangbourne Hill, Pangbourne, Reading, Berks. (*Tel. Pangbourne 2052*.)

**GW3MQX**, P. Lane, H.M. Coastguard Station, Rhossili, Swansea, Glam., SA3 1PR.

**G3NGF**, Rev. A. W. Shepherd, WAMRAC Headquarters, Lawn House, West Felton, Oswestry, Salop. (*Tel. Queens Head 366*.)

**G3NJB**, World Association of Methodist Radio Amateurs and Clubs, WAMRAC Headquarters, Lawn House, West Felton, Oswestry, Salop. (*Tel. Queens Head 366*.)

**G3NNT**, S. J. Pilkington, The Quarries, Quarry Drive, Aughton, Ormskirk, Lancs.

**G3TAR**, R. E. Roberts, 15 Pineside Avenue, Cannock Wood, Rugeley, Staffs.

**G3UAO**, A. L. Gilham (*ex-ZC4UA*), 8 Stokesay Place, Buntingdale Estate, Market Drayton, Salop, TF9 2HF.

**G3UGO**, Mrs. Edna Cooper, The Firs, Treskerby, Scorrier, Redruth, Cornwall.

**G3VJB**, G. W. Cooper, The Firs, Treskerby, Scorrier, Redruth, Cornwall.

**G3VYZ**, L. W. Thompson (*ex-G13VYZ*), 43 College Road, Blandford Camp, Dorset.

**G3YYU**, M. O. Binns, Harelaw House, 3 Main Street, Caldecott, Market Harborough, Leics., LE16 8RS.

**G3ZDF**, J. J. Kirk, 94 Hoddern Avenue, Peacehaven, Newhaven, Sussex, BN9 7QU.

**GM3ZDH**, R. A. Dixon, 20 Summerfield Cottages, Glasgow, G14 0RB.

**G3ZFF**, G. Gibson (*ex-DL5YO/9V1PY*), 1 Westfield Terrace, Flimby, Maryport, Cumberland.

**G3ZOH**, B. R. George, 20 Tile Farm Road, Orpington, Kent.

**G4ABS**, D. Bedford, 87 Linksfield Road, Westgate-on-Sea, Margate, Kent.

**G4ACB**, J. Leaver, 4 West View, Eaves, Hebden Bridge, Yorkshire.

**G4ADR**, N. E. Ayres, Glendevon, Thame, Oxon., OX9 3NQ.

**G4APL**, P. N. F. A. Lewis (*ex-G8DYZ*), 20 Annes Walk, Caterham-on-the-Hill, Surrey, CR3 5EL.

**G4QU**, F. C. Mason, Oakdene, Hill Top, Stanton, Bury St. Edmunds, Suffolk. (*Tel. Stanton 597*.)

**G6ACS/T**, R. B. Wilson, 81 Clarence Road, Derby, DE3 6LR.

**G8AGO**, J. Truscott, 11 St. Luke's Close, Westgate-on-Sea, Kent.

**G8BPA**, M. E. Kirk, 9 The Fairway, Mablethorpe, Lincs.

**G8BWG**, N. Toovey, 136 Woodhead Road, Holmbridge, Huddersfield, Yorkshire.

**G8CHI**, A. P. Tidder, 146 Heath Road, Hounslow, Middlesex, TW3 2NS.

**G8DLX**, M. T. Crampton, 16 Percival Road, Rugby, Warks.

## LOUGHBOROUGH TECHNICAL COLLEGE

Principal: F. Lester, B.Sc., Ph.D., F.R.I.C.

### Department of Electrical Engineering

Applications are invited for places in September 1973 on the following full-time course:—

### Diploma in Radio, Television and Electronics

Applicants for this three-year course should expect to gain "O" level or good CSE grades in Mathematics and a Science subject and be keenly interested in electronics.

A large element of practical work and two periods of industrial placement are included. Students will also sit for Parts I and II of the City and Guilds Technicians Certificate in Radio, Television and Electronics.

Further details may be obtained from:

**G. M. Allen, B.Sc.(Eng.), D.L.C., C.Eng., M.I.E.E.,**  
**Head of Department of Electrical Engineering,**  
**Loughborough Technical College,**  
**Radmoor,**  
**Loughborough, Leics., LE11 3BT Tel: 5831**

## CALLBOOK

(1973)

The "Call Book" proper is now published only once a year, in December, in two parts, "U.S." and "DX Listings."

Supplements to both editions appear at quarterly intervals, obtainable by prior order direct from the publishers.

We supply the "Call Book" as an annual publication, as required at any time during the year. We shall not be handling the quarterly supplements. These will be available only direct from the publishers.

This comprehensive reference lists about 300,000 licensed radio amateurs in the United States Directory and 160,000 or more in the rest of the world (contained in the "DX Section"). In the U.S. Section, licence classifications are shown with revised listings of new licences, names and addresses. The CALLBOOK also includes much incidental DX information. Every amateur operator and SWL needs the CALLBOOK to get the most out of Amateur Radio.

**DX Listings £2.95**

**U.S. Listings £3.75**

The above prices include postage and packing.

**Your order to:**

**Publications Dept.,**

**SHORT WAVE MAGAZINE**

**55 Victoria Street, London, SW1H 0HF**

**01-222 5341**

## SMALL ADVERTISEMENTS

("SITUATIONS" AND "TRADE")

6p per word, minimum charge £1.00. No series discount. All charges payable with order. Insertions of radio interest only accepted. Add 50% for Bold Face (Heavy Type). Box Numbers 15p extra. No responsibility accepted for transcription errors. Replies to Box Numbers should be addressed to The Short Wave Magazine, 55 Victoria Street, London, SW1H 0HF.

### SITUATIONS

**RADIO Amateur/TV Engineer seeks situation in East Anglia.—M. N. Corbett, G4BIY, Ivy Cottage, Barham Green, Ipswich, Suffolk, IP6 0QQ.**

**ANTENNA Design & Development Engineer:**  
 Electronic design and development engineers are required to join expanding company engaged in the design and development of antenna systems and RF feed-line components. The work covers siting assessment, the design and manufacture of antennae and associated components, and systems function testing in the HF, VHF, UHF and microwave spectrums.

We design, develop and manufacture antennae for use on aircraft in addition to ground and sea-borne systems, and applicants with some aircraft experience would receive early consideration. Applicants at all levels of qualifications and experience are required.

Salaries will be negotiable and commensurate with experience. The company is situated in a de-

lightful rural setting one mile from Witney, Oxfordshire.

Apply by letter: **H. R. Smith (Technical Developments), Ltd., New Mill, Crawley Road, Witney, Oxfordshire.**

### TRADE

**TOKO Filters:** CFT-455A, CFT-470C, 60p each plus 5p postage. Discounts for quantities. Send s.a.e. for details.—**Harrogate Radio Co., 2-3 Sykes Grove, Harrogate, HG1 2DB, Yorkshire.**

**WANTED:** Early wireless transmitting and receiving equipment from years 1900-1925. Marconi tuners 103, 106, CM-294 and any others. Also magnetic detector, coherer, Marconiphone V2, and amateur and ship receivers. Early telegraph gear, and any item marked "Silvertown." Please give description and prices.—**Dr. David Spence, 11 Brookfield Street, Cornholme, Todmorden, Lancs.**

**UHF High-Pass Filters:** Suitable for fitting in UHF/TV antenna lead. In many cases these have proved successful in eliminating TVI. Price £1.75 each. **E. & E. Services, 72 Elmstone Road, Rainham, Kent.**

**QSL Cards:** For Tx, G8/3 and SWL, one to 4-colour designs; good selection; large s.a.e. for samples.—**Printon Printers (R/Rose), 105 Fleetwood Street, Preston, Lancs.**

**S-METERS** suitable for R.C.A. AR88 D/LF receivers. 2½-in. diameter, 5 mA full-scale deflection, right-hand zero, complete with detailed fitting instructions, price £4.75 each, post paid. Also available, spares for AR88 D/LF receivers, send s.a.e. for list.—**A. J. Reynolds, 5 Headland Way, Lingfield, Surrey.**

**QSL** Cards for Tx and SWL. Send s.a.e. for samples stating which type required.—**Beaumont, G5YV, 8 Ashfield Avenue, Morley, Leeds, LS27-0QD.**

**QSL CARDS** and G.P.O. approved Logs (hard back). prompt delivery. Send 4p stamp for samples.—**Atkinson Bros., Printers, Looe, Cornwall, PL13-1JT.**

**YORK Photo-Audio Centre** offer the following Yaesu Equipment at reduced prices, these items having been used for showroom display only and sold as unused with guarantee: FT-101, £225; FT-560, £176; FT-75 £90; FR-400, £108. FL-2000B, £134. FL-50B, fitted Vox, £65. Credit terms arranged. Also a few second-hand receivers and transmitters available; our up-to-date list by return. Your camera equipment taken in Part Exchange—and we also accept communications equipment in exchange for Cameras and Hi-Fi gear.—**51 Fossgate, York (56176),** or 25798 after hours.

**APRIL Issue: Due out March 30.** Single-copy orders 30p, post free, to reach us by Wednesday, March 28, for posting on March 29.—**Circulation Dept., Short Wave Magazine Ltd., 55 Victoria Street, London, SW1H-0HF.**

**THOUSANDS** of Radio Bargains: Transmitters, receivers, relays, motors, meters, components, test equipment, valves, etc., etc. Send s.a.e. with enquiries.—**Auto Traction, 27A Arragon Road, Twickenham, Middlesex. (Tel: 01-892 9489).**

**TELERADIO ELECTRONICS:** Stockists of Trio receivers, Mobile communication and Hi-Fi equipment.—Enquiries welcomed at **325-7 Fore Street, Edmonton, London, N9. (Tel: 01-807 3719).**

**WALKIE-TALKIES:** No. 88 ex-W.D. 14-valve four channel transmitter/receiver unit, £5, carriage 62p. No. 17 ex-W.D. unused valved transceiver unit, 2v./120v., price £2.25, carriage 50p. **No. 19 Sets,** used transceiver valved unit, only £5, carriage £1. **Salvage** telemeter unit, multi-valve receiver, with speaker and tape unit, in sealed cartons, cost vast amount, price £3.75, carriage 75p. **Surplus** telephone handsets, 97½p. post/packing 17½p. **American** unused ex-W.D. quality feather-weight low-resistance headphones, £1.50, post/packing 15p. **Various** meters and spares in stock. Callers welcome.—**Southern Surplus Merchants, Ltd., 66 London Road, Kingston-on-Thames, Surrey. (Tel: 01-546 9263).**

#### READERS ADVERTISEMENTS

3p per word, minimum charge 50p payable with order. Add 25% for Bold Face (Heavy Type). Please write clearly, using full punctuation and recognised abbreviations. No responsibility accepted for transcription errors. Box Numbers 15p extra. Replies to Box Numbers should be addressed to The Short Wave Magazine, 55 Victoria Street, London, SW1H 0HF.

#### READERS

**SELLING:** Hy-Gain 18-AVT/WB 10-80m. trapped vertical, only few months' use, £25 or near offer.—**Cockayne, G3DAA, 9 Foresters Terrace, Teignmouth (3303), Devon.**

**FOR SALE:** Cambridge AM-10D, dash mounting, 12v. input, working on two metres. Rx tunable. Tx has three channels (one xtal on 145 MHz fitted). all circuits supplied, £25. Also Japanese Hi-Mound semi-automatic bug key, £2.50.—**Axford, G4AQZ, Dorfolk House, Landermere, Thorpe-le-Soken, Clacton-on-Sea, Essex.**

**SALE:** RTTY Creed 3X T/P, 160v. DC, £4; Type 44 perforator, £3; AM/CW Tx, coverage 160-10m., 40 watts, £15.—**Ring Rush, G3YKR, Emsworth 5612 (Hants.).**

**FOR SALE: Trio 9R-59DS** receiver with fitted voltage regulator, Hamgear PM-V crystal calibrator, speaker, phones, 4RF ATU, £40, Rx in "as-new" condition with original packing, etc.—**Ring Sounes, Rayleigh 4331 (Essex) after 7 p.m.,** or call at 1 Avondale Road, Rayleigh.

**WANTED:** 75p paid for copy of October 1971 "Short Wave Magazine."—**Huggins, Villiers House, Eton College, Windsor, Berks.**

**WANTED: HRO coil packs for 14-30 MHz,** will collect within reasonable distance.—**Chaplin, 36 Southern Way, Romford (45014), Essex.**

**SALE:** Eddystone 750 Rx, with matching speaker and S-meter, very good condition, fully aligned, £45 or near offer.—**Lindars, 52 Heathcote Drive, East Grinstead (23950), Sussex.**

**WANTED:** Receivers SP-600, 888A, Eddystones, W-H-Y? Exchange or p/exchange for (or sell) 3 month old G.E.C. 2084 UHF 20in. TV, Audio-master replay unit with tapes, £35; or new TV Hi-Fi gear.—**Snowden, Swainsea Lane, Pickering, Yorks.**

**WANTED: Audio filter FL8A.**—**Meiklejohn, Deer Close, Horsehouse, Nr. Leyburn, Yorks.**

**FOR SALE:** Two-metre Tx, 20 watts, with crystal, needs slight attention, £12; 160m. valve converter, IF 7-7.2 MHz, mains PSU, good condition, £8; Pye Ranger 2107, boot mounting, with control box and mic., Rx separate, Tx modified for 2m., PSU needs attention, £6. Carriage paid on all items.—**Forse, Penlan, St. Stephens, Saltash, Cornwall PL12 4AP.**

**EXCHANGE:** Leak Stereo-20 amplifier, Point-One stereo preamp, Rogers FM tuner (mono), FOR best receiver offered, such as AR88, Eddystone, W-H-Y?—**Snowden, Swainsea Lane, Pickering, Yorks.**

**WANTED: R.216 VHF receiver.** Wiring diagram with details of set and its associated AC power supply (if possible), must be clear, good price paid.—**Reynolds, River View, Lower Montenotte, Cork, Eire.**

**WANTED Urgently:** Circuit diagram and servicing information for the Pye Base Rx, Type 3004 VA. Will pay reasonable price.—**Varey, The Cottage, Ings Lane, Molescroft, Beverley, Yorkshire.**

**SELLING: Hallcrafters SX-146 receiver, Hallcrafters HT-46 transmitter with accessories, £400** or near offer.—**Glencross, Worth Abbey, Crawley, Sussex.**

**"DIGITAL Computer Logic and Electronics":** Four volume self-instructional course, £2.95 including post/packing. Money back guarantee.—**Cambridge Learning (SW), 8A Rose Crescent, Cambridge.**

**WANTED: Lafayette HA-500 circuit, manual or** aligning details. Loan or purchase.—**Byrne, 35 Endsleigh, Douglas Road, Cork, Eire.**

**SELLING:** Heathkit SB-102 Tx/Rx with SB-600 PSU, speaker, £175; Trio 9R-59D Rx, £35; Mobile 160m. Tx/Rx with Tavasus coil aerial inverter, £35.—**Hughes, GW3ZAO, QTHR.**

**SELLING:** Eddystone 680X receiver with loudspeaker, etc., re-valved, in good condition, £60 or PART EXCHANGE for Eddystone EC-10 receiver.—**Habesch, 65 Grange Road, Rhyl, Flintshire.**

**FOR SALE:** Lafayette HA-350 receiver, 80-10m., with 100 kHz calibrator, £30; stabilised PSU, 200 mA, 200-400v., £10; 144 MHz transmitter and converter, £5.—**Ring Punnett, 01-642 5712.**

**WANTED:** FB Heath HW-32A with PSU, AC or DC or both.—Parr, G3EPQ, 147 Main Road, High Harrington, Workington, Cumberland. (Tel: Harrington 680).

**SPRING SALE:** Marconi TF937 (CT-218) professional signal generator, coverage 85 kHz to 30 MHz, AM/CW/FM, 90 kHz deviation, internal calibration, four modulated frequencies, new, in transit case, £85; TF885 video oscillator, 25 Hz to 5 MHz, square and sine wave, 30v. output, with manual, £25; EHT PSU, 2.5 kV at 15 mA, variable, stabilised, £5; CT-82 VHF noise generator, £4; Type 13A scope, completely overhauled, new CRT, £20; B.40 Rx, with miniature valves, S-meter, re-aligned, £20.—Ring Jackson, 01-689 2727.

**SALE:** FT-75 with mobile supply, full set of crystals, £100.—Walker, G3AZT, Woodcote, Tubney, Abingdon, Berks. (Tel: Frilford Heath 398).

**WANTED:** Single-band SSB transceiver, 80m. or 20m., in mint condition. Cash paid. Details and price, please. Club meetings every Wednesday at 8 p.m., please call or write.—Star Short Wave Club, New Inn Hotel, Bramley Town Street, Leeds 13.

**WANTED:** R.C.A. AR-8516L in mint condition. **SELLING:** AR88D, reconditioned.—Chisholm, 141 Stanmore Road, Glasgow S.2.

**SELLING:** Unused K.W. Atlanta Transceiver with power supply unit and guarantee, £150. Low-pass filter, 50 ohms, £4. Shure 201 mic., as new, £3.50.—Ring Goodbody, 01-592 7800.

**FOR SALE:** Trio JR-500SE amateur-band receiver with SP-5D speaker, set of spare valves, excellent condition, £45; Lafayette HA-600, fitted speaker, good condition, £30; **WANTED:** Trio TR-2200.—Price, G8FHH, Sherwood House, Brimpsfield, Glos.

**WANTED:** For SWL station at the "Star Short Wave Club," New Inn Hotel, Bramley Town Street, Bramley, Leeds 13, an Eddystone 888A receiver with speaker and S-meter, must be in mint condition, cash paid. Club meetings every Wednesday at 8 p.m., please call or write.—Leeman, G4BUU, 115 Ascot Drive, Seacroft, Leeds LS14 1HX, Yorkshire.

**WANTED:** Codar T-28 receiver, must be in excellent order.—Mathews, 21 Portman Avenue, London SW14 (Tel: 01-876 7868).

**WANTED:** Vibroplex Presentation Model; also Vibro-keyer. **SELL:** New FT-DX401, £200 (intend purchasing new "separates"). New K.W. LPF, £3.50. New K.W. Junior traps for 40/20/10m., £1.50. New Ten-Tec electronic keyer, £15. New Admiralty key, £1.50, Bauer key paddle, £1.50. Heath HD-10 electronic keyer, £10. Hy-Gain 18-AVT vertical Ae., £25. Labgear wide-band multiplier unit, £1.50. Large m/c voltmeter, 3500v. DC, £1.50.—Stone, G3JFC, 26 Crayford Way, Crayford (22489), Dartford DA1 4LQ, Kent.

**SELLING:** Trio JR-310 receiver with Trio calibrator and mechanical filter, one year old, very good condition, £65; KW-202 receiver, as new, £100.—Wilkinson, 104 Falkland Road, Greatfield Estate, Hull, Yorks. (Tel: 0482-791168).

**FOR SALE:** "G2DAF"-type Mk. II transmitter and receiver (matched pair), mechanical filters, fully operational and working on all bands, 160-10m., original cost £270, bargain at £99 complete. Buyer collects.—Brown, G3NUN, QTHR, (Tel: Parkstone 741964, Dorset.).

**SALE:** K.W. Vanguard CW/AM Tx, coverage 160-10m., excellent condition, £25.—Powell, G4ADX, QTHR (Tel: 021-373 1841).



**AMATEUR RADIO**  
**CHAS. H. YOUNG LTD.**

The Widest Range  
of Components in  
the Midlands.  
★ G2AK ★

<b>"J" BEAMS 2 metres and 70 cm. FULL RANGE IN STOCK. S.A.E. for list</b>	Carr. (50p)
<b>AERIAL ROTATORS:</b>	
CD AR 22 ROTATOR	£25.00 (50p)
CD AR 10 ROTATOR	£20.00 (50p)
CD TR 44 ROTATOR	£47.00 (50p)
STOLLE AUTOMATIC 2010	£27.50 (50p)
KW TRAP DIPOLES	£15.00 (27p)
KW TRAPS—WITH INSULATORS	£4.50 (20p)
KW BALUN	£2.30 (10p)
FEEDER 75 ohm	yd. 4p (25p)
RIBBON FEEDER 300 ohm	yd. 4p (25p)
COPPER AERIAL WIRE SOLID 14G. H/D 70ft.	95p (25p)
STRANDED 7/029 (BARE) and 32/0.2 mm. (COVERED) 140ft.	£1.87 (25p)
AERIAL INSULATORS RIBBED CERAMIC	ea. 12p (16p)
DIPOLE CENTRE PIECE CERAMIC	ea. 12p (10p)
POLYTHENE LINE ROPE 100 lb. 100 yd.	63p (16p)
200 lb. 100 yd.	£1.25 (16p)
400 lb. 100 yd.	2p (16p)
LOW LOSS COAXIAL CABLE 75 ohm	yd. 25p (24p)
LOW LOSS COAXIAL CABLE 50 ohm	yd. 25p (24p)
HI GAIN VERTICAL 14 AVQ	£24.50 (50p)
TRIO RECEIVER 9R 59DS	£49.50
TRIO RECEIVER JR 310	£75.00
EDDYSTONE EC10 Mk. II	£26.00
KW RECEIVER 202	£140.00
CODAR RECEIVER CR70A Mk. II	£27.50
CODAR PRE-SELECTOR PR 40	£8.90 (30p)
KW 2000B TRANSMITTER	£240.00
KW TRANSMITTER 204	£145.00
CALSON DIGITAL CLOCKS 24 HR. FROM HAMMERITE PAINT (All cols. S.A.E. for list) from "RAYMART" ABSORPTION BAND CHECKER	19p
1.8 MHz-32 MHz	£5.25 (25p)

(Carr. shown in brackets)

**Chas. H. Young Ltd.**

No C.O.D. Please print your address. Enquiries S.A.E. Fast Mail Order. 021 236 1635

170 - 172 Corporation Street, Birmingham, B4 6UD

## MI-19467-A MASTER OSCILLATORS

These R.C.A. units which are used in the ET 4336 transmitter and which were supplied as a separate item, each in its own slide-in metal case, are ideal as the heart of any high-power transmitter, unmodified as a low-power (approx. 20w.) transmitter, or as a basis for modification to suit individual requirements. They incorporate a 6-position oscillator switch (covering 1 to 5 MHz); a 3-position Multiplier switch (covering 2 to 10 MHz); a D.C. current meter, and oscillator and multiplier coils with "turns counting" mechanisms for precise tuning. Power requirements are H.T. and L.T. for the 807 valve used in the unit, and are brought in by an 8-pin Jones plug on the rear of the chassis. The basic frequency coverage of the oscillator is 1 to 10 MHz, which can be extended to 20 MHz when used as the oscillator section of a higher power transmitter or when used on its own. All these and many more details are covered in full in the extremely comprehensive instruction/service manual (supplied with each unit) containing wiring and circuit diagrams, adjustments, photographs, etc. **BRAND NEW.** Price per unit is **£8.50** including 2, 807 valves. Carriage **£1.50.**



## COLOMOR ELECTRONICS LTD.

01-743 0899 01-748 8006

**170 GOLDHAWK ROAD, LONDON, W.12**

## DERWENT RADIO

5 COLUMBUS RAVINE, SCARBOROUGH. Tel. SCA 65996  
 Showroom open Tuesday/Thursday/Friday/Saturday  
 MEMBER OF THE AMATEUR RADIO RETAILERS ASSOCIATION

KW103 swr/power ...	£12.50	Trio JR599 ...	£185.00
KW 2000E and A.C. p.s.u.	£265.00	Trio 9R59DE ...	£49.00
KW Atlanta and p.s.u.	£210.00	Trio SP 5D speaker ...	£4.00
KW 202 receiver ...	£140.00	Trio TS 515 transceiver	£210.00
KW 204 transmitter ...	£160.00	Trio TX 599 transmitter	£185.00
KW I07 AE match unit ...	£46.00	RCA IC manual ...	98p
KW EZ match ...	£15.00	RCA Hobbies manual ...	76p
KW I01 swr bridge ...	£8.20	RCA Valve manual ...	98p
KW AE switch ...	£4.25	RCA COS/MOS ...	98p
KW Balun ...	£1.95	G Whip tribander ...	£10.50
KW Atlanta VFO ...	£37.00	G Whip 160/80m. ...	£9.00
Eddystone EC10 Mk. II ...	£86.00	G Whip 160 Ranger ...	£7.50
Eddystone EC10 A.C. p.s.u.	£7.75	G Whip base mount ...	£1.45
Yaesu FT 401 ...	£230.00	G Whip LF coils ...	£4.00
Yaesu FT101 ...	£255.00	Lafayette HA 600 ...	£50.00
Yaesu FT200 and p.s.u.	£172.00	Lafayette HA 800 ...	£57.00
Yaesu FR400S ...	£160.00	Codar CR70A receiver	£27.00
Yaesu FL400 ...	£146.00	Codar PR40 ...	£8.50
Yaesu FR50B ...	£59.00	Codar 12/RC cti unit ...	£2.50
Yaesu FL50 ...	£68.00	Codar Multiband 6 ...	£11.50
Unica URIA Rx. ...	£25.00	Wight traps standard ...	£2.75
Unica UNR30 Rx. ...	£14.75	Yaesu coils; hi power ...	£3.75
Transistor Rx. with 2M	£10.00	Stereo/Mono head-	
TE15 GDO ...	£12.50	phones ...	£1.99
Hanson swr bridge ...	£4.20	Shure 201 microphones	£5.50
Double meter swr ...	£7.75	Shure 444 ...	£14.00
5 band RF meter ...	£4.00	Acos Mic 45 ...	£3.00
Katsumi EI bug 9K9X ...	£8.50	Yaesu p.t. ...	£3.00
Type 500 test meter ...	£8.85	'J' Beam Halo ...	£1.35
Mini test meter ...	£2.20	Boom mic crystal ...	£4.60
Sentinel 2m. converter	£13.75	Boom mic ceramic ...	£4.95
Sentinel 4m. converter	£15.75	4 digit impulse counter	10p
Sentinel 70cm. converter	£13.75	10 Crystals our selection	65p
Sentinel 2m. pre-amp	£6.50	50 resistors ...	16p
Soldering irons from ...	£1.45	10 ceramic capacitors ...	10p
2 way intercom ...	£2.10	10 silver mica caps ...	10p
'15' Dec ...	£1.00	Amphenol PL259 PTFE	30p
AR20 rotator ...	£20.00	Amphenol SC239 PTFE	30p
AR21R ...	£25.00	Amphenol SC239	25p
3/167-5/9v. D.C. p.s.u.	£4.00	Amphenol reducer ...	8p
2,000 ohm headset ...	90p	10 0-1 Mfd caps 400v. ...	17p
C60 cassettes ...	30p	Double sided copper clad	7p
Cassette recorders A.C./		Paxolin 8" x 7" ...	3p
D.C. ...	£15.00	2N3819, BF100 ...	35p
0-20v. D.C. p.s.u. IA stab.	£10.75	BC107, 108, 109 ...	10p
2 1/2" speaker 8 ohm ...	35p	250 ohm carbon pots ...	25p
3" speaker 8 ohm ...	40p	10 GSL strips (120 cards)	25p
24v. relay ex equipment	10p	RCA 6LQ6 ...	£2.60
12v. relay ex equipment	15p	RCA 3N140 Mosfet ...	85p
5 mixed relays ...	10p	RCA 3N141 ...	85p
6 BA bolts pack ...	10p	'146 IIT ...	£1.80
6 BA nuts ...	10p	All RSGB publications stocked.	
Pack 20 ICs with data ...	£1.00	RSGB Callbook, post free	65p
Trio JR310 Rx. ...	£75.00	Dosemeter ...	10p
		Type 10 Xtal calibrator	£2.75

A good chance to stock up with top grade disc ceramic capacitors. Most values 2-2 pfd to 1 mfd, send 10p stamp for full lists and samples. 50p for stock parcel (post 6p).

We are looking for good condition modern transmitters and receivers etc. and will pay cash or give good trade in prices. Please let us have details with s.a.e. for offer.

PLEASE ADD EXTRA FOR CARRIAGE. S.A.E. FOR LISTS  
 MAIL ORDER TO: DES WOOD, G3HKO  
 28 HILLCREST AVENUE, SCARBOROUGH, YO12 6RQ  
 (Telephone 63982)

### SURPLUS BARGAINS

Trans. Pria 230v. Sec. 2.25Kv. ct. at 565 Ma., size:  $6\frac{1}{4} \times 5\frac{1}{4} \times 4\frac{3}{4}$ ". Price £7. Also Sec. 415-143-0-143-415v. at 360 Ma on 415v. and 120 Ma on 143v., size:  $5\frac{1}{2} \times 4\frac{1}{2} \times 4\frac{1}{2}$ ". Price £3. Choke 1-9Hy 800 Ma to match above. Price £1.50. Headphone matching trans. with lead and standard jack plug 5ft. with 4000 to 250 ohm matching trans. Price 50p. Blower Motors double ended full cont rating 27.5v. D.C. 3-8a however will work on 6 to 27.5v. at reduced O/P. Outlets  $1\frac{3}{8}$  sq., overall size  $6 \times 3\frac{3}{4}$ ". Price £1.65.

The above prices inc. post; all above new boxed American surplus.

**A. H. SUPPLIES,**  
 57 Main Road, Sheffield S9 5HL

**FOR SALE:** TV monitors, 21-in. all-metal construction, 625 line, working order, £10. **WANTED:** Ex-broadcast television equipment, cameras, mixers, cable, fittings, etc.—Summers, G8GQS, 7 Orchard Close, Morton, Gainsborough (3940), Lincs.

**SELLING:** Hallicrafters SX-117 Rx, triple conversion, covering all HF bands in 500 kHz segments, £75 or near offer. Phasing-type SSB Tx, coverage 10-80m., with PSU and 2/6146 in final, low styling, £45 or near offer.—Ledger, G3UBL, 7 Beamish Drive, Bushey Heath, Herts. (Tel: 01-950 3443).

**SALE:** Joystick lightweight antenna with Joymatch Mk. III tuner, coverage 1.5-30 MHz, £8.50. Carriage paid.—Mickleburgh, 13 Elizabeth Road, Porlingland, Norwich, NOR 42W.

**SALE:** Codar T.28, modified for mains/battery, internal speaker, improved BFO, £14; BC-454B "Command" receiver with separate AC/PSU and speaker, coverage 3-6 MHz, £6; also FTC-401 transistor tester, £5. Buyers collect.—Ballance, G3KNB, QTHR (Tel: Stafford 62105).

**BARGAIN:** Yaesu Musen FR-400SDX Rx, four mechanical filters, etc., two years old, needs slight attention, offers over £85. Buyer collects. (Lancs.)—Box No. 5126, Short Wave Magazine Ltd., 55 Victoria Street, London, SW1H-0HF.

**WANTED:** Trio JR-60 receiver in working order. Details and price, please.—Smith, 19 Hyde Road, Kenilworth (54609), Warks.

**SELLING:** Eddystone 830/7 receiver with plinth speaker, little used, immaculate condition, purchased new three years ago, offers over £300. Also Koyo 11-band portable, mint condition (cost £69 three months ago), £40. (Glos.)—Box No. 5127, Short Wave Magazine Ltd., 55 Victoria Street, London, SW1H-0HF.

**SALE:** Heath HW-32 with home-built mains PSU, good condition, £45.—Ring Willmott, Shoeburyness 3475 (Essex).

**SELLING:** De luxe Joystick and 4RF ATU, as new, £9.50. DX-400U low voltage transformer, new, £8. Gelson crystal microphone, £2.50.—Thompson, G3RCZ, 24 Verdure Close, Failsworth, Manchester.

**WANTED:** Heathkit RA-1 receiver with loud-speaker, crystal calibrator and handbook, in good condition. Also Joystick aerial less ATU.—Roberts, 9 High Street, Bala, Merioneth, LL23 7AG, North Wales.

**SALE:** UHF receiver, tunable front-end, with IF unit 1000 to 2600 MHz, and 2300 to 4450 MHz, £15. Avometer Model 7 test meter, £16.50.—Box No. 5128, Short Wave Magazine Ltd., 55 Victoria Street, London, SW1H-0HF.

**EXCHANGE:** Murphy B.40C Rx, in good condition, modified aerial, and mains plugs. **FOR** miniature-valve version of B.40D, with cash adjustment. **WANTED:** B.40 bandswitch knob (Note: not for above Rx!); also wobulator unit for use with Cossor 339 'scope.—Clyne, 78 Halford Road, Uxbridge, Middx. (Tel: Uxbridge 30006, evenings and weekends).

**SALE:** American VHF/UHF Rx, coverage 75-1000 MHz, £65; American panoramic receiver, £25; CRT oscilloscope, £6; CRT PSU, £5; IF amplifier, 45 MHz, £3; IF amplifier, 30 MHz, £3; AC/PSU Type 234, £5; American Tx chassis, £1; Command Set/VHF Rx, £20; Gyroscope motor, £2. Carriage extra. s.a.e. with enquiries please.—Hayward, Sunnyfields, Lighthouse Road, St. Margaret's Bay, Dover, Kent.

**SELLING RECEIVERS:** Racal RA-17, coverage 0.5-30 MHz; Eddystone 770R, coverage 19-165 MHz; Converter, 36-1000 MHz. Silicon rectifiers, 1250v./1½ amp., 10p each; s.a.e. please.—Wright, 249 Sandy Lane, Hindley, Wigan (55948), Lancs.



**SELLING:** KW-2000 with AC/PSU, recently serviced by firm, good condition, £105.—Appleby, G4AFM, QTHR (Tel: 061-439 8555, Cheshire).

**FOR SALE:** HW-17A transceiver with AC/DC PSU, £55; Codar AT.5 Tx with 12v. PSU and 12RC control; Halson whip, 160/80m. coils, £25.—Denman, G3MEW, QTHR (Tel: Portsmouth 20315).

**SALE:** Eddystone 888 Rx, with S-meter, in very good condition, £50. Emsac CN2M converter, IF 28 to 30 MHz, £6. Lafayette KT-320 communications Rx kit, complete, £15. Electroniques Coilpax QC-166, with gen., £11; also matching IFA/1.6/SSB Mk. III unit, with gen., £5—or the pair for £15. Calrad DM-16HL microphone, brand new, £3. Armstrong Stereo-Twelve AM/FM radiogram chassis, with manual, £10. Pair Goodmans "Triaxette" speakers, 15-ohm, rated 10 watts, £10, Garrard TA Mk. II turntable, price £2. Buyers collect these items. **WANTED:** FT-2FB equipment.—Day, 38 Woodstock Road, Begbroke, Oxford (086-75 2215).

**FOR SALE:** R.209 Rx, Mk. II, in working order, £10. Also 12-volt vibrator unit, £3. Buyer to collect.—20 Allen Street, Maidstone, Kent, ME14 5AG.

**APRIL Issue Short Wave Magazine due out on Friday, March 30. Single copies at 30p post free can be supplied to orders reaching us by Wednesday 28th, for despatch on Thursday 29th, the day before publication. These copies go out flat in an envelope, first-class posting. Orders with remittance to:— Circulation Dept., Short Wave Magazine, Ltd., 55 Victoria Street, London, SW1H-0HF.**

**SALE:** Trio 9R-59DS receiver with SP-5D speaker, stabiliser, 500 kHz calibrator, £37.50; Shure 444T microphone with built-in pre-amp, £11; TTC SWR bridge, £3; E.M.I. GDO, £3-50. Buyer to arrange carriage.—Poulter, G3WHK, 279 Aragon Road, Morden, Surrey. (Tel: 01-337 0117).

**FOR SALE:** FT-101 transceiver, mint, guaranteed February '73, £190; Kycritsu GDO, £8; Empire Aristocrat portable typewriter, £10 or near offer. Numerous TV valves, new but in tired wrappings, ex-dealer stock, cheap.—Morris, G4HU, QTHR.

**SALE:** Aerial rotator with Parvalux/Jeary motor, reversible, 230/250v., 52lbs./in. at 5 r.p.m., mounted in steel tripod frame, driving 3-in. steel rod 18-in. long in ballrace, 5 only, £10 each, plus £1 carriage.—Barnes, 14 Laurel Drive, Eccleston, St. Helens, Lancs. (Tel: 051-966 2393, daytime).

**SELLING:** Sommerkamp FT-100 transceiver (property of the late G3NXXF), best offer over £90 for quick sale.—Bevington, G5KS, QTHR. (Tel: 021-552 1409).

**EXCHANGE OR SELL:** KW-202 receiver with calibrator, 5 months old, £100. Consider PART-EXCHANGE for late model unmodified KW-77.—Newey, 23 Leahouse Road, Oldbury, Warley, Wores.

**MANUALS:** B.40, T.C.S., RA-17, £1.75; R.210, R.216, J.4, 8516L, £2; CR-100, CR-300, AR88LF, £1.25. Add postage.—Brooks, 5 Farrant House, Winstanley Road, London, SW.11.

**SELLING:** B.40 receiver, £12 (buyer collects); two-metre transistor converter, IF 4.6 MHz, £4; Sentinel 2m. FET pre-amp, £4; PR-30X pre-amp, £5.—England, G8GJV, 81 Rounds Hill, Kenilworth, Warks. (Tel: Kenilworth 52599, after 6 p.m.).

**SALE:** Eddystone 888A receiver with S-meter and speaker, £65.—Druce, 6 Kennedy Drive, Goole, Yorks.

G2CTV

G3ZY

**J. & A. TWEEDY (Electronic Supplies) Ltd.**

MEMBER AMATEUR RADIO RETAILERS ASSOCIATION

Yaesu Musen :		Trio :	
FT101, 160 to 10 ...	£255	9R59DS G.C. Receiver...	£49.50
FR200 with FP200 p.s.u. ...	£172	JR310 Ham band Receiver	£75.00
FT401 Transceiver ...	£230	JR599 Ham band Receiver	£185
FRSDX400 Receiver ...	£160	TX599 Transmitter ...	£185
FLDX400 Transmitter ...	£146	TS515 Transceiver with	
FL2000B Linear ...	£148	p.s.u. ...	£210
FR50B plus Calib plus		TL911 Linear ...	£140
VVVV Receiver ...	£63.00	TR2200 2 metre Trans-	
FL50B plus VOX Trans-		ceiver ...	£62.50
mitter ...	£72.00	SP5D Loudspeakers 8 ohm	£4-50
FT2FB 2 metre Trans-			
ceiver ...	£89.00	<b>Caslon Clocks :</b>	
FT2 Auto. 2 metre Trans-		Copal 601 ...	£13.75
ceiver ...	£146	Copal 222 ...	£6.65
		Copal 101 ...	£8.80
		Copal 602 ...	£11.50

<b>KW Electronics :</b>	
KW107 ...	£46.00
KW Ezee Match ...	£16.50
KW Trap Dipole 97ft.	
co-ax ...	£16.00
KW202 Receiver ...	£140
KW204 Transmitter ...	£160
KW 2000E Transceiver	£265
KW103 SWR and power	
meter ...	£12.50
KW Baluns ...	£2-30

<b>Spacemark :</b>	
ETM2B Keyer ...	£23.80
ETM3B Keyer ...	£25.95

<b>C.D. Rotators :</b>	
AR20 ...	£20.00
AR22 ...	£25.00
TR44 ...	£45.90

<b>Aerials :</b>	
Mosley J Beam, Hy-Gain, Tavasu,	
"G" Whips, Telomasts.	

<b>Hamgear :</b>	
PM2B Preselectors ...	£9.20
PM2B Preselectors, Solid	
state ...	£8.25
PMV Calibrators ...	£7.75
PMVIII Calibrators ...	£11.75
PMIII Converter. 1-8	
MHz-7 MH ...	£10.50

SWR Bridges by KW, Osker, Asahi, etc.

<b>Boom Mikes</b>	
Model C ...	£5.75
Model X ...	£5.40
Model C with switch	£7.30
Model X with switch	£6.95

**Used Equipment :**  
Heathkit RA1 + calib., £27.50; DX40U + vfo, £25; Trio 9R59DE, £30; JR500SE, £45; JR599, £140; Lafayette HA350, £45; Sommerkamp/Yaesu FT150, £150; FRDX500, £105; FRDX 400, £105; FV101, £25; KW "G" line 2000, £110.

Open Tuesdays to Saturdays, 9 a.m. to 5.30 p.m.  
HP terms available Part exchanges

**79 CHATSWORTH ROAD  
CHESTERFIELD S40 2AP**  
Tel.: 4982 Tel.: 68005 evenings

**WORLD RADIO/TV  
HANDBOOK 1973**

The World's only complete reference guide to International Radio & Television Broadcasting Stations. It includes: Frequencies, time schedules, announcements, personnel, slogans, interval signals and much more besides of value to the listener.

Lists all International short-wave stations, including frequencies, for each country; for ign broadcasts, long and medium wave stations (AM broadcast Band), TV stations and domestic programmes. Long recognised as the established authority by broadcasters and listeners. It is the only publication that enables you to identify BC stations quickly and easily. Enables you to fill more pages in your log book on the SW BC bands and helps you add more BC-station QSL cards to your collection.

**£3.00**

(The above price includes postage and packing).

from:

**SHORT WAVE MAGAZINE**  
55 Victoria Street, London, SW1H 0HF

**FOR SALE:** HW-12A, excellent condition, without PSU, £35; Barlow-Wadley XCR-30, as new, £70 or near offer; K.W. Pepmeter, little used, £5; Lab-gear compressor, £3.—Coull, Domel, Elham, Kent. (Tel: Elham 244, evenings).

**SALE:** K.W. Vespa Mk. II (6LQ6), with PSU, very good condition, £80; Sommerkamp FT-100, £85; Shure 444 mic., £7.—Tibbert, G3RKZ, 11 Darwin Road, Mickleover, Derby (511434).

**SELLING:** RITTY Creed 75 printer with reperforator attachment, synchronous motor, 45 and 50 baud gears, single current; 6S5 autotender with 240v. AC governed motor, manuals, tuning fork, paper and ribbons, in perfect order and professionally serviced, £60. DL6EQ converter with toroids and input B/P filters for SSB and normal tones; AFSK units; Heath OS-2; T/P table, £15. Buyer collects. K.W. E-Zee Match; 75 dummy load; TTC SWR; Medco LFP; Heath speaker; all co-ax leads, £15.—Cooper, G2UD, QTHR. (Tel: Brighton 34924).

**SALE:** "G2DAF"-type Rx Mk. II, complete but not working, etched rack mounting case, £35 or near offer.—Ellis, 13A Lower Edgeborough Road, Guildford, Surrey.

**SELLING:** Sommerkamp FR-100B Rx and FL-200B Tx, good condition, £130 the pair; Pyramid linear, 400 watts p.e.p. output, £25.—Buckley, G3VLX, QTHR. (Tel: 01-467 8093).

**FOR SALE:** Codar AT-5 Tx, slight modification for 40m. operation, good condition, £19; Trio 9R-59D Rx with SP-4 speaker, good condition, £39. Carriage paid.—Olds, G3KFP, QTHR.

**SELLING:** Trio JR-310 receiver with SP-5D speaker, mint condition, £60. Will deliver about 30 miles. Joystick with Joymatch 3A tuner, £10.—Ring Grant, 01-472 6073.

**SELLING:** Mint FT-DX401/FV-401, 6 months old and little used, £240; Trio 9R-59D with fitted stabiliser, mint condition, best offer near £35.—Maxfield, G3ZRQ, 40 Fegg Hayes Road, Stoke-on-Trent ST6 6RA, Staffs. (Tel: 0782-35160 between 12.45 and 1.15, Mon.-Fri.).

**FOR SALE:** KW-2000B with AC/PSU, mic. and K.W. dummy load, £160.—Jenkins, G3VTW, 135B Wembley Park Drive, Wembley, Middx. (Tel: 01-902 1979).

**WANTED:** Two Pye Bantams, low-wave band, state number of channels, condition and price.—Gough, Heather Croft, Ravenscar, Scarborough, Yorks. (Tel: Cloughton 320).

**SELLING:** Normende "Globetrotter Amateur," 15 bands, individual calibrated bandspread, all broadcast and amateur bands 80-10m., with LM/VHF/Top, mains/battery, BFO, double conversion, ideal mobile Rx, £50; National NC-190X, bandspread, all amateur and broadcast bands, double conversion, S-meter, matching speaker, £50. Both Rx's in excellent condition.—12 Malton Way, York (59035), Yorkshire.

**OFFERING:** Two-metre Rx, BF180 RF, diode-mosfet mixer, Fet oscillator, double-conversion, with BFO, 0.5 microvolt sensitivity, £30. Two-metre all-transistor Tx, 12-volt, on commercial boards, 5 watts RF output AM, £35. TV camera, Grundig transistor, 625-line video out, good Vidicon, £35.—Levitt, G8AXY, QTHR, or ring 061-430 2451.

**FOR SALE:** KW-103, 75-ohm, new, £9. Mosley V3 Jr, for 10-15-20 metres, with 25 yds. 52-ohm coax, £6. Filter, 75 ohm, £2.—Ring Hunt, G2FSR, Brighton 503958.

**DISPOSING:** Few copies "DX Listings" 1972 CALL BOOK, at only £1.50 each post free, to clear. First come, first served.—Publications Dept., Short Wave Magazine, Ltd., 55 Victoria Street, London, SW1H-0HF.

**SALE:** KW-202/204, speaker, as new, very little used, £240. Also TA-33Jr, beam, £10.—Richardson, 25 Constance Crescent, Hayes, Bromley, Kent.

**EXCHANGE:** Cossor CC.302 low-band, perfect working order, 25 watts of F3, six channels, FOR similar high-band unit.—Ring Naylor, Nottingham 334176.

**SALE:** Eddystone round speaker and Eddystone mains filter unit, both unused and as new, £4.75 or near offer.—Ring Barrington, 01-462 1600.

**SELLING:** Oscilloscopes — Cossor Type 1035, £15; '1049, £25. Solartron CD513.2, £25; CD711S.2, £39. T03 portable, £27. Also a BC-221B freq. meter with PSU, £18. Robuk RK-4 three-speed tape recorder, £20.—Whitbread, G8AYN, QTHR, Crayford (Kent) 24625.

**SALE:** SB-620 Spectrum Analyser, mint condition, £50. Also Hartley Type 13A double-beam scope (18 x 10 x 13-in.), price £20.—Tompkins, G3SWV, QTHR, or ring 01-777 1579.

**SALE:** FT-DX560 with C.W.F. and FV-40DS, pair going for £185. Hy-Gain 14AVQ vertical, two months' use, £21. K.W. trap dipole, 97-ft. with balun—LP filter—twin meter SWR bridge—Z-Match; with all connectors, condition as brand new, going as one unit, £40. Mobile antenna, G-Whip, used for less than four hours, coverage 10-15-20-80m., £15. All letters with s.a.e. answered.—Miller, 70 West Road, Newport-on-Tay, Fife, Scotland.

**SELLING:** BC-639A receiver, coverage 99 to 158 MHz, £20; BC-348Q, £15; BC-453B, less outer case, £5. Mains xformer for S.36A, £4.50. S.27 output xformer, £1.25. BC-625 modulation transformer, £1. Wooden cabinet for BC-221, £2.50. Blank calibration book for BC-221, £1.50. Heavy-duty rack, 6-ft. x 19-in., £2.50. Perforator, 7PN3, £11. Dust cover, 7B, £1. Incomplete keyboard, £1.50. Tape printing attachment, £1.50. Tuning fork, 125 Hz, £1.50. Maintenance manual, T/P's Nos. 7 & 8, £3. Illustrated parts manual, £3. A.T.M. regenerative repeater, £5. Book "Telegraphy" by J. W. Freebody, £2. CR-100 manual, £1.75. Replacement R.216 film-strip dial, £1.25. Carriage extra or buyers collect.—Reynolds, 5 Headland Way, Lingfield, RH7 6DH, Surrey.

**FOR SALE:** Type 7B/RP teleprinter, in good condition, with end-of-line-lamp mod., N3 type keyboard, £25 or near offer. Teleprinter Type 7B, well maintained, £15 or offer. Fibre-glass P.C. boards for "Wireless World" T/P demodulator, complete with layout drawings, all boards roller-tinned with gold-flashed 0.156-in. spacing-edge connectors, price £7 per set. Tested 4CX250B valves, £3 each. NE561B PLL, £5. SN7490N, 60p. SN7412N decade/decoder/latch/Nixie driver, £2.30.—Perkins, G3OUV, QTHR, or ring High Wycombe (0494) 21612 after 6.0 p.m.

## MORSE MADE !!! EASY

**FACT NOT FICTION.** If you start RIGHT you will be reading amateur and commercial Morse within a month. (Normal progress to be expected.)

Using scientifically prepared 3-speed records you automatically learn to recognise the code RHYTHM without translating. You can't help it, it's as easy as learning a tune. 18-W.P.M. in 4 weeks guaranteed. For Complete Course 3 Records & Books send £4.50 (overseas £1 Extra).

For further details of course Ring 01-660 2896/01-668 3255 or send 4p stamp for explanatory booklet to: G3HSC (Box 14) 45 GREEN LANE, PURLEY, SURREY

**ESSENTIAL BOOKS**

**COSMIC RADIO WAVES.** Start a new hobby—Radio Astronomy. This big book of 444 pages is an ideal handbook for the beginner and established enthusiast. Numerous photographs and illustrations. Published by Oxford University Press. Price £2.50, p.p. 25p.

**GOVERNMENT SURPLUS WIRELESS EQUIPMENT HANDBOOK.** Contains circuits, data, illustrations and valuable information for British/U.S.A. receivers, transmitters, trans/receivers. With modifications to sets and test equipment. Latest impression, £3.25, incl. postage.

**PROBLEMS IN ELECTRONICS WITH SOLUTIONS.** A must for the student, technician, and electronics engineer. Contains 349 problems, answers and how they were arrived at. Includes all aspects of electronics including aeriels, filters, transmission lines and networks, waveguides, semiconductors, amplifiers, power supplies, etc. 307 pages. Ideal for R.A.E. studies. Only 90p, p.p. 10p.

**HOW TO MAKE WALKIE-TALKIES FOR LICENSED OPERATION.** Only 40p, incl. postage.

Available from: **GERALD MYERS (SW)**  
18, SHAFTESBURY STREET, LEEDS LS12 3BT.  
Extra postage for abroad

**FREE TO ENGINEERS**



Whatever your age or experience you must read New Opportunities. It describes the easiest way to pass A.M.S.E., A.M.I.M.I., City & Guilds (all branches), Gen. Cert., etc., and gives details of courses in all branches of engineering Mechanics, Electrical, Civil, Auto, Aero, Radio, TV, Building, etc. You must read this book.

Send for your copy today—FREE!  
B.I.E.T., BSW03 (CX), Aldermaston Court, Reading, RG7 4PF  
Accredited by the Council for the Accreditation of Correspondence Colleges

**BRITISH INSTITUTE OF ENGINEERING TECHNOLOGY**

**BERNARD MYERS BOOKS**

- COIL DESIGN AND CONSTRUCTION MANUAL 35p post paid
- HANDBOOK OF TESTED TRANSISTOR CIRCUITS 45p post paid
- HOW TO MAKE AERIALS FOR T.V. (Band 1 & 3) AND V.H.F. (Band 2) 23p post paid
- HIGH FIDELITY LOUDSPEAKER ENCLOSURES 45p post paid
- RADIO & ELECTRONIC COLOUR CODES & DATA CHART 21p post paid
- RADIO TELEVISION AND ELECTRONICS DATA BOOK 30p post paid
- TRANSISTOR CIRCUITS MANUAL No. 1 21p post paid
- HANDBOOK OF TRANSISTOR EQUIVALENTS & SUBSTITUTES 45p post paid
- HANDBOOK OF RADIO, T.V., & INDUSTRIAL TUBE & VALVE EQUIVALENTS 45p post paid
- SOUND & LOUDSPEAKER MANUAL (No. 8) 56p
- WORLD'S SHORT WAVE MEDIUM & LONG WAVE RADIO STATIONS & FM & TV LISTING 41p post paid

Available from

**SHORT WAVE MAGAZINE**

Publications Dept., 55 Victoria Street, London, SW1H 0HF 01-222 5341/2  
(Counter Service, 9.30-5.15, Mon. to Fri.)  
(Nearest Station: St. James's Park)  
(GIRO A/c. No. 547 6151)

**IS YOUR STATION COMPLETE ??? NOT WITHOUT A DIGITAL CLOCK IT ISN'T !!**



**THIS FABULOUS '222' IS YOURS FOR ONLY £6.65**

Made by Copal, the world's largest manufacturer of Digital Clocks, it is absolutely reliable and accurate. Mains powered (negligible consumption) with 24 hour read out and built in diffused lighting. Available in White, Charcoal, Flame & Advocado Green. Size: 5" x 2 1/2" x 2 1/2". We sell the complete range of Copal Clocks, all at rock bottom prices, and would specially recommend:—

**COPAL'S LATEST, THE '227'**—A beautiful 24 hour Mini Digital Clock with alarm buzzer in Black, White, Red and Yellow. Size: 5 1/2" x 3 1/2" x 2 1/2". (See Dec. '72 S.W. Mag. for a photograph.) **ONLY £8.25**

**THE SUPERB '601'** with day, date etc., in a case of Satinised Aluminium. 24 hour. Size: 8 1/2" x 3 1/2" x 4". **ONLY £13.75**

**FREE: POST, PACKING AND INSURANCE**

All OUR clocks are carefully checked and tested, fully guaranteed for 12 months, and if you are not completely happy we give a full refund without question.

**DON'T DELAY—SEND TODAY—FOR IMMEDIATE ATTENTION**

**AERO & GENERAL SUPPLIES**

NANAIMO HOUSE, 2 RINGWOOD AVENUE, LEEDS LS14 1AJ  
Telephone 658568

*The Unique*

**MULTI-MINI VICES**

UNIVERSAL—ADAPTABLE—PORTABLE

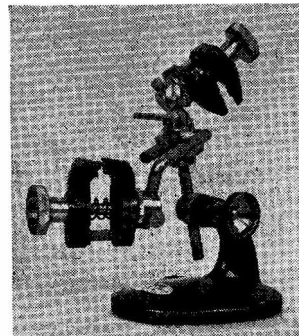

An extra "PAIR OF HANDS" for those tricky jobs  
**ASSEMBLY  
SOLDERING  
DRILLING  
GLUING  
WIRING  
CLAMPING ETC**

● Jaws adjust 360° in all directions

● Jaws can be detached and used separately for clamping

● 'V' Grooves in jaws to firmly hold round parts.

**TWIN** MODEL

DESIGNED ESPECIALLY FOR RADIO, T.V. AND ELECTRONIC ENTHUSIASTS!

**TWIN VICE: £8.95** (26p p. & p.)

Carriage prices for delivery outside U.K. will be extra.

ALSO AVAILABLE

**SINGLE VICE: £5.45** (22p p. & p.)

V.A.T.—Orders despatched before 1st April 73 free of V.A.T.

**CANLEY ENGINEERING (SALES) LTD.**  
DEPT. C/S.2. OSBORNE ROAD,  
COVENTRY CV5 6EA.

TEL: (0203)-77163/4.

**REG. WARD & CO. LTD.** (G2BSW)

WE ARE OFFICIALLY APPOINTED K.W. AGENTS FOR THE SOUTH WEST (Somerset, Dorset, Devon, Cornwall)

KW Atlanta with p.s.u.	£210-00
Remote VFO	£37-00
KW 2000B with p.s.u.	£240-00
Remote VFO	£39-00
KW 2000E TCVR; & A.C. p.s.u.	£265-00
KW 202 Receiver	£140-00
Matching Speaker	£8-00
KW 204 Transmitter	£160-00
KW 1000 Linear	£135-00
KW 101 VSWR Meter (52 or 75 ohm)	£8-25
KW 103 VSWR Meter and Combined Power Meter	£12-50
KW E-Z Match, 10-80m. ATU	£16-50
KW 107 Combined E-Z Match, VSWR and R.F. Power Indicator, Dummy Load and Antenna Switch for 4 Outlets	£46-00
KW Trap Dipole 70' 75 ohm Twin Feeder	£15-00
KW Trap Dipole 97' Coaxial Feeder	£16-50
KW Trap Dipole with Balun	£18-50
KW 3 way Antenna Switches (for coax)	£4-25

**YAESU**

FR50B Amateur Bands Receiver	£59-00
FT101 260w, Transceiver, with mic., spkr. and built-in A.C./D.C. p.s.u. (with Top Band £255-00)	£249-00
FR50 + Cal VVWV	£63-00
FT200 Transceiver	£134-00
FP200 A.C. p.s.u.	£38-00
FR400SDX Rx. (with 160 and 2m.)	£160-00
SP400 Speaker	£10-00
Caslon 24 hour Digital Clocks	£7-50

**EDDYSTONE RECEIVERS**  
 EC10 Mk. II, £86; 830/7, £372-75; New Model 1000, £210.  
 WE ARE THE DISTRIBUTORS OF EDDYSTONE PROFESSIONAL RECEIVERS FOR THE SOUTH WEST.  
 Trio Equipment Model 9R59DS £49-50  
**SECOND HAND EQUIPMENT** in stock: K.W. Atlanta Transceiver, £175; Star SR 200 RCVR: 10-160m. with x'tal cal. Excellent, £35-00; KW 202 RCVR with matching SPKR as new, £130-00; Eddystone 840 RCVR (G/coverage), £30-00; Eddystone 840c, £40-00; Eddystone EB35 £47-50; Trio 9R59 DS £39-50.

**SHURE MICROPHONES**  
 Model 44A, £14-40; Model 201, £6; Model 202, £6-60.  
**ANTENNAE** J-Beam 2 metre Beams in stock. Also Joustick and Joymatch A.T.U.'s, Stolle Ant. Rotators, 140ft. coils 14G. Copper Antenna Wire & Ribbed Insulators.  
**R.C.A. VALVES** for KW and Heathkit equipment, 6146, 6146B, 6HF5, 6L06, 6G05, 6EAB, 6GWB, 6GK6, 6CM6, 6CL6, 6CB6, 6BN8, 6HS6, 6EW6, 12BA6, 12BE6, 12BE5, etc. and many other types.  
**TRADE INS WITH PLEASURE. OUR STOCK OF GOOD SECOND HAND EQUIPMENT CHANGES DAILY - LET US KNOW YOUR REQUIREMENTS.**  
 WE STOCK R.S.G.B. PUBLICATIONS, LOG BOOKS, Etc.  
 HP TERMS AVAILABLE CARRIAGE EXTRA ON ALL ITEMS.  
**AXMINSTER - DEVON Telephone: 3163**

**EMUVERTER**  
**2 METRE CONVERTER**

★ Plug in dual gate Mosfets, 116 MHz xtal, image rejection circuit, 28-30 MHz I.F. 12v. supply used.  
 £16 including postage

**EMUPRESSOR**  
**SPEECH PROCESSOR**

★ Battery powered, placed between mic. and Tx.  
 ★ Virtually constant output for a wide input range, enables mod to be kept to an optimum over a wide range of speech levels.  
 ★ Accepts input signals from 1mV to 1v.  
 ★ Suitable for AM, FM or SSB.  
 £7-80 including postage

**EMUMARKER**  
**CRYSTAL CALIBRATOR**

★ Provides separate outputs at 1 MHz, 100 kHz and 10 kHz spacings up to 450 MHz.  
 ★ Set up on Droitwich 200 kHz standard before dispatch.  
 ★ Requires 9v. supply.  
 £7-80 including postage

MONEY BACK GUARANTEE ON ALL PRODUCTS

**I. N. CLINE, G3EMU**  
**15 KNIGHT AVENUE,**  
**CANTERBURY, KENT,**

**G3EKX S.S.B. PRODUCTS G3EKX**

**SPECIALLY MATCHED VALVES FOR LONGER LIFE**

PAIR MATCHED 6HF5's R.C.A....	(20p)	£5-50
PAIR MATCHED 6146 R.C.A. ....	(20p)	£5-00
PAIR MATCHED 6146B R.C.A. ....	(20p)	£6-20

**CRYSTALS.** New metal cased types. Mixed freq's from 201 kHz to 110 MHz. Please clearly state requirements and alternatives. Essential an s.a.e. is enclosed for reply. From  
 (5p) ea. 60p  
 1-450, 2-5, 10-245, 24 MHz. Spot On (5p) ea. 75p

**SCARAB.** S.S.B. Tx + lattice Filters. Plus matching carrier xtal. (HC6/U xtals) all parts, instructions + 3 band-Tx. Circuit. Hundreds in use. (30p) ea. £8-99

**MORSE KEYS.** Heavy brass. On wood base. Type C/1056A, back contacts. Large terminals. Unused, boxed (30p) ea. £1-20

**SUPERB R.C.A. ROTARY RELAYS.** 12v. D.C. input (hold in coil). Ideal for aerial switching 160m. to 2m. Changeover contacts. (3-sets) Only (24p) ea. 60p

TRIO 9R59DS. New stock	£49-50
EDDYSTONE EC10. Mk. II	£86-00
EDDYSTONE 924. Power packs	£7-75
EDDYSTONE 940 (mint)	£110-00
EDDYSTONE 770R (excellent)	£95-00
TRIO TRANSCEIVER. TSS10/PS510. New	£180-00
AR88D. (excellent)	£55-00
MARCONI CR150	£28-00
CLASS "D" W/METERS A.C./mains	ea. £11-00

(Carriage extra please)

**1 FRANCES STREET, TRURO**  
**Tel. DEVORAN 862575 CORNWALL**

**ENSIGN ELECTRONICS**

Morse Keys. New and boxed with lead and plug (62 Set type)	65p
Headphones with Mic. New and boxed (62 Set type)	£1-00
Sets of spare valves for 62 Set. New	£1-35
New Eagle 0-300 volt D.C. Meters. 3" square	£1-10
AR88 SPARES: I.F. Transformers (L.F. model), 35p; Crystal Load Coils, 25p; Wavetraps, 40p; Resistance Boards, 75p; Coils—10 mixed, 75p; Knobs—medium (Jap.), 16p.	
New Marked 2N3055 Transistors	35p
100 Mixed High Stability Resistors	35p
43" 8 Section Telescopic aerials	35p
67" wire aerials. Marked every foot	60p
Aircraft Mach Meters	70p
Slide Switches 4 for	30p
10 1/2" Revox Tape Spools	40p
Headphones with Boom Mic. (used)	£1-45
Min Silicon Bridge Rectifiers. 50 volt 1 amp.	25p
IN4005's 600 volt P.I.V. 1 amp.	12p each, 12 for £1-30
Valves: E180cc 20p, Ruggedised E.F.91's	20p
Telephone Handsets	40p
Amber Panel Mounting Neon Indicators	20p
CAPACITOR OFFER: 100 mfd 12 volt, 5p; 33 mfd 16 volt 5p; 0.05 mfd, 0.02 mfd, 0.002 mfd, 50 volt discs, 12 for 15p; 50 for 50p.	
'Min' 'Battery Levels' Meters. 0-600 M.A.F.S.D.	50p
813 valves. New and Boxed	£1-50
Adjustable Hole Cutters	50p
Set of 6 ex U.S.A.F. Maps (large, all different)	60p
Lightweight Headphones—New and Boxed	£1-00
PLUGS. 3-pin Din Plugs, 12p; Standard Jack Plugs, 14p; Phono Plugs 6p. Std Jack Sockets 12p.	
Trimmers: Air Spaced 0-25 pf, 12p; 0.5-5 pf screwdriver type, 8p.	
8' 4 Section Whip aerials	75p

All Prices include Postage and Packing. Minimum Order 30p

**SPECIAL OFFER.** Ferric Chloride Powder for printed circuit etching. Full instructions. 1 lb. bag, 40p; 3 bags, £1

**30 HIGH STREET, QUORN,**  
**NR. LOUGHBOROUGH, LEICS.**



# become a RADIO-AMATEUR!

learn how to become a radio-amateur in contact with the whole world. We give skilled preparation for the G.P.O. licence

**free!** Brochure, without obligation to: SWB-33

**BRITISH NATIONAL RADIO & ELECTRONICS SCHOOL P.O. BOX 156, JERSEY, CHANNEL ISLANDS**

NAME: \_\_\_\_\_

ADDRESS: \_\_\_\_\_

BLOCK CAPS please

## THE AMATEUR RADIO SHOP 64MH

13 CHAPEL HILL, HUDDERSFIELD,

Telephone: 20774

(MEMBER OF THE AMATEUR RADIO RETAILERS ASSOCIATION)

Agents for Eddystone, Yaesu, KW, Trio, J Beam  
Barclay Card, H.P., etc.

BEAT V.A.T. BEFORE APRIL 1st, SAVE 10%

Now in stock:

Full range of KW: 2000E, 2000B, 202, 204, 1000LIN, 107, 103, Eze Match, Antenna Switch, etc.

Full range Trio: TSS15, TL911, TX599, JR599, JR310(160), 9E59DS, TR2200, Filters, Mics., etc.

Yaesu: FT101(160), FT200, FT401, FT400SDX, FR400, FR50B, FL50B.

Accessories: Copal 222, 12 hr., £5; Copal 222, 24 hr., £7; Copal 601, 24 hr., £14.95; T.T.C. SWR Ind., £6.75; Shure Mics. 201, £5.75; Shure 444, £12.50; Shure 444T, £16; Shure 401, £6.75. Rotators, Beams, Cable, Calves, etc.

Crystals: HCGU 8012-5, 8018-75, 8031, 25, 8033-33, 8035-4, 8037-S, 8041-66, 8054-16 at £1 each. 10XJ (CR1/AR) 8001 to 8107. S.A.E. lists, at 75p each.

Morse Practice Oscillator including Integrated Circuit, Loud Speaker fully wired, 90p incl. post.

The 4 MH 2 Metre Tx now available again 16 watts input xtal supplied, £11.50. Also matching Modulator EP86-ECC83-2XEL84, £11.50. S.A.E. details.

Second-hand: ---

JR599 ... ..	£140	Viceroy Mk. III ... ..	£55
EA12 ... ..	£140	AR88LF ... ..	£32
KW201 ... ..	£78	AR88D ... ..	£35
770R ... ..	£95	Eddystone 840C ... ..	£28
Home made Lin ... ..	£25	KW 2000B ... ..	£170
FP20 Pan Adaptor ... ..	£50	SR550 ... ..	£35
Wichers 2 metre Communicator ... ..	£35	Heath HW 17 ... ..	£55
		HA350 ... ..	£55

WANTED ALL TYPES OF GEAR FOR CASH

S.A.E. for any gen.

CLOSED TUESDAYS, LATE NIGHT THURSDAYS

73 G4MH, G3NEW

## INSIST ON VERSATOWER

Acclaimed as the World's leading telescopic tiltover tower in the field of radio communication Models from 25' to 120'

Enquiries to  
Western Electronics (UK) Ltd  
Osborne Road, Totton, Southampton

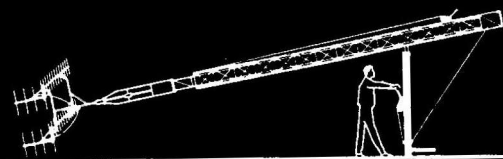

Look for the name

**STRUMECH**

Strumech Engineering Co Ltd  
Coppice Side, Brownhills, Walsall, Staffs.

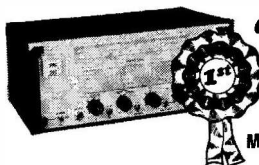

## another WINNER from EDDYSTONE

Model 1000 Communication Receiver

This is the latest communication receiver from the Eddystone stable. Covering C.W., M.C.W., A.M. and S.S.B. Powered by integral power pack (rechargeable) or A.C. mains. Other features include single conversion using I.C., F.E. and bi-polar transistors, desensitizing facilities, carrier level meter and separate fine tune control. £210.00

Pop along and see them now... whilst we still have some in stock.

The EDDYSTONE E.C.10 Mk 2 is still alive and thriving at Imhofs. This modest priced communication receiver embodies features usually found in more expensive designs. £86.00



## impak pack-flat instrument cases for the home constructor

These cases will give your home constructed equipment that professional look at a modest price. Four sizes available complete with a satin finish aluminium front panel.

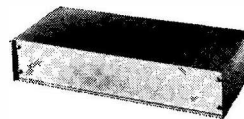

WRITE FOR COMPREHENSIVE LEAFLETS ON ANY OF THE ABOVE

**IMHOFS**

DEPT. 11/3  
112-116 NEW OXFORD STREET  
LONDON ENGLAND WC1A 1HJ

R72

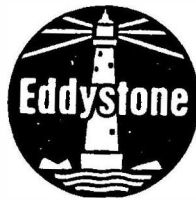

**"LISTEN TO THE WORLD WITH EDDYSTONE"**

**Your local Eddystone dealer is:**

**CHESHIRE**

The Transistor Centre (Wilmslow) Ltd  
Green Lane  
Wilmslow 24766

**CORNWALL**

R. V. Heming Ltd (Peter Heming G3WBW)  
Cliff Road, Newquay  
Newquay 2191

S.S.B. Products (Norman Birkett G3EKX)  
1 Frances Street  
Truro  
Devoran 862575

**DEVON**

Reg. Ward & Co. Ltd: G2BSW  
Axminster  
Axminster 3163

**ESSEX**

F. E. Smith  
184 Moulsham Street  
Chelmsford  
Chelmsford 54594

**HAMPSHIRE**

Southern Marine Radio (Southampton) Ltd  
Solent House, Town Quay  
Town Quay 22721

**IRELAND**

John F. MacMahon  
10, Church Street, Enniskillen  
Co. Fermanagh, N. Ireland  
Enniskillen 2955

**LANCASHIRE**

Holdings Photo Audio Centre  
Mincing Lane - Darwen Street,  
Blackburn BB2 2AF  
Tel. 59595

Stephen-James Ltd  
70 Priory Road, Anfield  
Liverpool L4 2RZ  
051-263 7829

North West Electrics  
769 Stockport Road  
Levenshulme, Manchester 19  
061-224 4911

Croftfilm Ltd  
46 Friargate  
Preston PRI-2AT  
Preston 55244

**LEICESTERSHIRE**

A. K. Davey Ltd  
New Street, Hinckley  
Hinckley 2173 and 4288

**LONDON**

Imhofs (Retail) Ltd  
112-116 New Oxford Street  
W.C.1  
01-636 7878

R. T. & I. Electronics Ltd  
Ashville Old Hall  
Ashville Road  
Leytonstone, E.11  
01-539 4986

Radio Shack Ltd  
188 Broadhurst Gardens  
London, N.W.6  
01-624 7174

**NORTHUMBERL'D**

Aitken Bros. & Company  
35 High Bridge  
Newcastle upon Tyne NE1 1EW  
Newcastle upon Tyne 26729

**WALES**

Holt High Fidelity  
Picton Arcade, Swansea  
Swansea 53254

Holt High Fidelity  
8 Portland Street, Swansea  
Swansea 41032

**WARWICKSHIRE**

Chas. H. Young Ltd  
170/172 Corporation Street  
Birmingham 4  
021-236 1635

**TAURUS ELECTRICAL SERVICES**

26-28 NOTTINGHAM ROAD, LOUGHBOROUGH, LEICS.

Telephone: 05093-5131



We stock all TRIO communication equipment and most of the SOMMERKAMP gear. If we've not got it we do our uttermost to get it for you. Now we have ACCESS for purchasers of all Amateur Radio equipment, New and Second-hand.

**THIS MONTHS BARGAINS**

<b>BOXED NEW 4CX250 BASES</b> ... Complete with chimneys and securing clips ...	£3-20
<b>NEW MULLARD 1" END-ON NIXIE TUBES</b> ...	£1-30
Bases for same ...	12p
<b>807 BASES</b> ... each	10p
<b>FIELD STRENGTH METERS</b> ...	£3-10
<b>NEW EDDYSTONE 10.7 Meg. IFs</b> ...	12p
RF Chokes ...	10p
Large Knobs ...	25p
<b>NEW GORLER Dual IF Amplifiers, 10.7 Meg. and 465 kc/s. with circuit</b> ...	£3-20
Spare last IF's for above ...	15p
<b>NEW 8Ω 3" Loudspeakers</b> ...	35p
40Ω 2" Loudspeaker ...	40p
<b>SHURE LOW IMPEDANCE MIKES</b> ...	£1-75
<b>DESK HIGH IMPEDANCE MIKES</b> ...	£3-25
<b>ACOS MIC 40</b> ...	£1-50
<b>HAND MIKES</b> ... 80p, 90p and £1	
<b>SLOW MOTION DIALS</b> ...	
Small 65p Medium 85p Large £1	
<b>TELEPRINTER 7B's in stock</b> ...	£15-00 to £25-00

*All goods advertised last month still available*

<b>OSCARBLOCK SWR and POWER METERS</b> ...	£18-50
<b>FX2000 CRYSTAL MARKER GENERATORS 100 kHz/50 mHz with switchable modulator</b> ...	£5-75
<b>MG 100 AUDIO GENERATORS sine and square wave, 19 Hz - 220 kHz...</b> ...	£17-50

All prices include carriage  
All orders over £2 confirmed by return if any delay  
You can order these goods by letter or telephone  
**SIMPLY QUOTE YOUR ACCESS NO.**

**FREE FIELD EFFECT TRANSISTOR with all orders this month**

Experiment with new branded I.C.'s—not seconds—  
Bargain pack contains: (a) Linear Amplifier 709  
(b) Thyristor 100 p.i.v. 0.3 amp  
(c) 18 mixed D.T.L./T.T.L. I.C.'s  
20 items all marked—with outline data, £1 + 10p carr.  
I.C. Tape Recorder Amplifier 1 watt—with circuit, 40p + 5p carr.  
I.C. A.M. Radio 700 m/w—with circuit, 75p + 5p carr.  
I.C. Wide Band Amplifier + F.M. Discriminator—with circuit, 35p + 5p carr.  
I.C. 16 Bit Memories, 35p + 5p carr.  
709 OP. Amp TO-5, 15p; DIL, 20p + 5p carr.  
Triacs: 450 P.I.V. 5 Amp—with circuit, 65p + 5p carr.  
400 P.I.V. 2 Amp—with circuit, 50p + 5p carr.  
Suitable diac, 24p + 5p carr.

**ELEY ELECTRONICS**  
112 GROBY ROAD, GLENFIELD,  
LEICESTER LE3-8GL

**TRIO For reliability**

Short Wave and Hi-Fi

Swop it for your camera

AT HOLDINGS MINCING LANE/DARWEN STREET BLACKBURN TEL: 59595

**2 METRE CONVERTERS**

**LOW NOISE R.F. STAGE F.E.T. MIXER.** Xtal controlled multiplier chain. Aluminium case. Size: 4" x 3" x 1 1/4". I.F.'s 4-6, 18-20, 24-26, 28-30 MHz, £10-50 each.

**2 METRE LOW NOISE CASCODED F.E.T. PRE-AMPS.** Aluminium case. Size: 2 1/2" x 1 1/2" x 1 1/4", £5-00 each.

**E & E SERVICES**  
72 ELMSTONE ROAD, RAINHAM, KENT

**SPECIAL 6 kHz CRYSTALS** in B7G envelope, £1.  
**50 PIV 1 AMP SILICON BRIDGES** at 25p.  
**VHF TUNING VARACTORS** untested usable up to 400 MHz, 50pf at 8 volt, 80pf at 4 volt, 6 for 25p.  
**HIGH VOLTAGE POWER TRANSISTORS NPN** 250 volt TO 66 case, 20p ea.  
**DUAL BG CRYSTALS** 28211-11 kHz-28344-44 kHz, 28000-00 kHz-28155-56 kHz, 28011-11 kHz-22144-44 kHz, 28-01111 MHz-28-14444 MHz, 28-40000 MHz-28-56667 MHz, 28-46667 MHz-28-64444 MHz, 28-08889 MHz-28-26667 MHz, 10-26296 MHz-10-30741 MHz, 10-39360 MHz-10-44074 MHz, 10-32963 MHz-10-37407 MHz, 10-39259 MHz-10-44815 MHz.  
**SINGLE CRYSTALS.** 21-750 MHz, 28333-33 kHz, 28-33333 MHz, 10-37037 MHz, Dual or Single Crystals, 15p ea.  
**MULLARD 4.7 volt, 5-6 volts, 8-2 volt 300 MW ZENERS, 7p ea.**  
**ITT BCY 43 GENERAL PURPOSE SILICON NPN TRANSISTORS, 5p ea., 40p doz.**  
**COMMUNICATION SERIES OF I.C.'s** untested 1 x R.F., 3 x I.F., 2 x VOGAD, 2 x AGC, 1 x Headphone Amp, 2 x Double Balanced Modulators, 1 x Mixer. The 12 I.C.'s for £2-75. Separate I.C.'s, 25p ea.  
**TEXAS FETS.** 2N 3819 at 30p, 2N 3824 at 20p, 2N 5245 at 40p.  
**MULLARD FETS.** BFV10 at 25p, BFV11 at 25p.  
**STANDARD M.O.S. P CHANNEL FET** with circuits at 10p ea. F.M. I.C.'s like TAA 570 untested with data. 5 for 50p.  
**1000pf Solder-in FEED THRO'S, 15p doz.**  
**47pf, 200pf, 220pf LEADLESS DISC CERAMICS, 15p doz.**  
**1000 PIV 1 AMP SILICON DIODES** at 10p ea.  
**BA 110 VARI-CAP DIODES, 20p ea.**  
**ELECTROLYTIC CONDENSERS.** 2500uf 30v.w. 1 1/2" x 1" short wires. 10p each, 3 for 25p.  
**UNTESTED PACKETS OF SEMICONDUCTORS**  
 10 10 amp Silicon Diodes at 25p      10 15 amp Silicon Diodes at 35p  
 10 20 amp Silicon Diodes at 50p      10 5 amp S.C.R.'s Push Fit at 30p  
 10 5 amp S.C.R.'s Stud Mounting      10 10 amp S.C.R.'s Stud Mounting      at 50p  
 10 2 amp Triacs at 50p      10 5 amp Push Fit Triacs at 50p  
 50 Silicon Planar NPN at 25p      50 Silicon Planar PNP at 25p  
 100 400 mA Zeners at 50p      100 2 watt Zeners at 50p  
**MULLARD BD 131 at 50p, BD 132 at 50p.**  
**S.C.R.'s Ex New Equipment 400 PIV 5 amp, 3 for 50p, 7 for £1.**  
**FT 271 200 kHz Crystals at 30p each.**  
**10 watt unmarked ZENERS 7.5 volt, 8.2 volt, 9 volt, 11 volt, 12 volt, 13 volt, 15 volt, 16 volt, 18 volt, 20 volt, 24 volt, 27 volt, 33 volt. All at 20p ea.**  
**Unmarked Good 2N 706 Transistors at 71p ea., 27p doz.**  
**Packet of 25 Printed Circuit Silicon Diodes untested from 50 PIV to 1000 PIV 500 mA at 25p.**

**J. BIRKETT**

Radio Component Suppliers  
 25 THE STRAIT, LINCOLN, LN2 1JF.  
 Telephone: 20767

**G. W. M. RADIO LTD.**

ALL ORDERS AFTER APRIL 1st - ADD 10% V.A.T. or phone for price.

**DOUBLE BEAM OSCILLOSCOPES CT436** (Military version of the Solastron CD1014) D.C. to Mc/s., 10Mv per Cm. sensitivity, clean and good order, £50 carriage paid.  
**RECEIVERS, TCS, 1.5 to 12 Mc/s.** Power needed 12v. A.C. or D.C. and 220v. D.C. Clean condition, £9-50, post paid.  
**PYERANGER.** High Band Radio Telephones, dash mounting PTC2002V. Clean condition, less crystals, £6, post paid. Murphy High Band TR621/25, £8 or Low Band TR801a, £7, post paid.  
**TRANSMITTER PA UNITS, STC T4188.** Tunes 2-8 to 18 Mc/s., manual or 28 volt motor driven, 13" x 8" x 8". Pair CV2518 (4X150) 28v. blower cooled. Bases are NOT UHF type. Ideal basis for Linear Amplifier construction, £8, post paid. Also available matching Receivers R4187. Complicated crystal controlled 28v. motor or manual tuned, £5-50 carriage paid.  
**PLESSEY PTR161.** 24v. 6 Channel remote Transmitter/Receiver, 116-132 Mc/s. QVO4/7 output. Size: 6" x 8" x 11". Weight: 16 lbs. Good clean condition and complete with circuit giving details of heater connections for 12v. operation, and suggested conversion details for 2 metres, £8, post paid.  
**REDIFON S.S.B.** Generator 6315/a 6 transistor plug in unit 9" x 6" x 1 1/2". No details. £1 post paid.  
**PARMEKO.** 200-250 Mains Transformers, output 0-4-5-6-3v. 2a, 85p, post paid. Larger potted type, 0-10-10-5-11v., 0-75a., 65p, post paid.  
**METERS.** 500 microamp calibrated 0-1-4 kilowatts, by Ernest Turner, Oblong 1 1/2" x 1 1/2". Also same make and specification but just over 3" square. Either type, £1-25 post paid. 500 ma 2 1/2" round, 60p, post paid. Crystal calibrators No. 10 for Army 62 set, £3-50, post paid. Hygro-meters, wet and dry bulb type, Centigrade, £1-25, post paid. Pre-set 7 x 7 pf split stators, 3 for 25p, post paid. Moving coil microphones No. 13 with Plessey plug for B44, 60p, post paid. Low impedance headphones with lead and two way jack, Aluminium headband, as new, £1-15, post paid.

**REED RELAYS for G3FCW** keyer. 4 reed, normally open, 200 ohms, coil, 15p each, post for any number 10p. Reed inserts 1-85p, 10p (body length 1-1/2"), diameter .14". Gold clad contacts switch up to 500ma at up to 250v. D.C., 63p per dozen, £3-75 per 100, £27-50 per 1000, post paid.

**LEDEX** 24v. D.C. motorised Yaxley switches, 21 wafers each 1 pole 6 way, £1, post paid. Attenuators, Marconi. 70 ohms 10 dB. Pye socket one end, special other, 50p, post paid.

All Receivers and Test Equipment are in working order at time of dispatch. Carriage charges quoted are for England and Wales only.

Terms: Cash with order. Telephone 34897. Early closing Wednesday

40-42 PORTLAND ROAD, WORTHING, SUSSEX

**MARKHAM ELECTRONICS**

Technical Sales  
 G3FPQ **YAESU TRANSCEIVERS** XYL

New equipment available from stock—12 months guarantee (excluding valves and semi-conductors)—Delivery by Securicor £3—H.P. terms available

<b>FT101.</b> 10 to 80 metres. (Superseded model)	
1 only ... ..	£220-00
<b>FTDX560</b> ... ..	£180-00
<b>FTDX560.</b> Fitted FT401 Noise Blanker ... ..	£195-00
Accessories—Free Delivery	
<b>FT101.</b> 160m. modification kit ... ..	£5-00

In addition to the equipment imported by us as listed above, we are now able to offer the whole Yaesu range at normal retail prices with free delivery.

In stock now new :

<b>FT101</b> + factory fitted 160 metres ... ..	£255-00
<b>FTDX 401</b> ... ..	£230-00

**MARKHAM OAK, BUCKS HORN OAK, FARNHAM, SURREY**

Telephone: Bentley (Hants.) 3168 (Evenings)

**SOLID-STATE RTTY CONVERTER-KEYER SRD-1**

- COPIES 850/400/170 HZ SHIFTS
- BUILT-IN SINGLE AND DOUBLE CURRENT PSU
- F.S. KEYS FOR TX (AND OPTIONAL AFSK)

Complete and ready-to-go for send-receive RTTY with TX, RX and teleprinter.

- Advanced circuitry, 6 ICs, 25 semi-conductors. ● Input matches receiver outputs 3-8 or 500-600 ohms. ● 3-pole Butterworth input bandpass filter. ● Switched 850/400/170 Hz Amateur/Commercial shifts but copies shifts 1000 Hz down. ● 2-pole low-pass filter. ● Tuning meter. ● Monitor scope outputs. ● Mark Hold and Normal/Reverse shift switch. ● Built-in loop PSU—Instant switch-selection of single- or double-current printers. ● Narrow-shift CW identification. ● F.S. Keyer output for TX. ● Socket and circuitry already fitted for optional plug-in AFSKeyer module, 850/170 Hz. ● Manual. ● Two-tone pvc-coated case, 9" w x 3 3/8" h x 14" d. Weight : 7 lbs. SRD-1, £49-50.

(Optional plug-in AFSK module, SRD1-AK, £5-75. SRD-1 complete with SRD1-AK, £55-00).

**RTTY CONVERTER-KEYER Model TTU, £120.** ST-5 PCBs and datasheets, £4-15. TOROIDS 88 mH, 75p per pair. ST-6 PCBs and datasheets, £11-75. ST-6 KIT complete less case, with datasheets, £62-50. SAMSON ETM-2b, £23-80. ETM-3b, £25-95. JUNKER Precision hand key, £9-75. BAUER keying lever, £3-80. SSB 90° AUDIO PHASE SHIFT NETWORKS, £2-95. PRINTSET Basi-kits.

All goods post-paid U.K. Send stamp for Catalogue SP5.

**SPACEMARK LTD.**

THORNFIELD HOUSE, DELAMER ROAD, ALTRINCHAM, CHESHIRE.

(Tel. 061-928 8458)

## SOME TITLES FROM FOULSHAM-SAMS

### ABC's of ANTENNAS

The introductory chapters cover the fundamentals of radio-wave propagation and basic antenna characteristics. The remainder of the book is then devoted to a discussion of the various types of antennas and their uses. Antennas for radio, television and two-way communications are included. Business radio, amateur, both mobile and fixed-station operation, are covered. The final chapter should be particularly appealing to those interested in microwave uses and radio-navigational systems. A perusal of this book will provide any student with an excellent foundation for more advanced study in antenna design.

89p

### AMATEUR RADIO SSB GUIDE

Single-sideband receivers, transmitters, and transceivers are now available which have higher frequency stability and are much easier to tune than the early models. In this book, the author presents a guide to single-sideband and single-sideband equipment, which will be useful to any amateur considering or already operating SSB.

By W6TYH

£1.59

### BEGINNER'S GUIDE TO RADIO

For many years "Beginner's Guide to Radio" has been extremely popular as an introduction to the subject of radio-and-how-it-works. The many advances made in recent times have rendered a new edition necessary.

This seventh edition has been completely rewritten and brought up-to-date to take account of the latest techniques and methods, and covers every aspect of the modern radio scene, while including the important basic information necessary for the newcomer to the subject. The reader is guided from the first principles of electricity and magnetism, through radio waves, modulation and radio components, including valves and transistors, taking in radio transmitters and stereo broadcasting, and ending with hi-fi reproduction.

The book will be of interest to all who wish to understand the how-and-why of radio, whether it be for a hobby or a profession.

Seventh Edition

£1.12 post free

### RADIO AMATEUR OPERATOR'S HANDBOOK

The opportunity has been taken of bringing this edition—the twelfth—right up-to-date and of incorporating extensive revisions. The book covers in detail the Post Office regulations governing the issue of transmitting licences.

The purpose of this Handbook is to provide all the information which the operator of a radio station may need about such matters as Country Prefixes, Call Sign Areas, Frequency Allocations, Standard Frequency Transmissions, Time Factors, Distance Tables, and so on. For the newcomer, this manual enables him to find the basic answers and to obtain the maximum pleasure from his hobby.

53p post free

### TRANSISTOR FUNDAMENTALS Vol. 1

This book is a carefully planned programmed introduction to semi-conductors and the basic electrical circuits. It begins with a brief description of transistors and later devotes an entire chapter to an explanation of transistor principles. Sandwiched between these chapters are explanations of voltage, current, and resistance; and the all-important Ohm's Law and Kirchhoff's laws. The book also looks at the more complicated nature of inductance, capacitance, and resistance in AC circuits.

£1.92

### TRANSISTOR FUNDAMENTALS Vol. 2

This volume describes transistors and how they are used in semiconductor circuits. Simple circuits illustrate the basic principles involved, and the more complicated circuits found in amplifiers and oscillators help to show how the basic operations are applied. Later, some recent semi-conductor developments are discussed. Detailed descriptions of four new transistor devices are given and how they are being used.

£1.92

### KNOW YOUR OSCILLOSCOPE

By Paul C. Smith

The oscilloscope provides you with a "third eye" which lets you see what is actually happening in electronic circuits. But you must know something of the nature of this valuable instrument, and how to use it, before it will serve you. This book presents complete information on the circuitry, functions, and applications of the oscilloscope in easy-to-understand language. Worthwhile reading for anyone who uses an oscilloscope... a "must" for service technicians and students.

£1.80

Most Books described here are American in origin.

The above prices include postage & packing.

Delivery is from stock.

Available from **SHORT WAVE MAGAZINE**  
Publications Dept., 55 Victoria St., London S.W.1. 01-222 5341

(Counter Service, 9.30-5.15, Mon. to Fri.)

(Nearest Station: St. James's Park)

(GIRO A/C. No. 547 6151)

### PRACTICAL INTEGRATED CIRCUITS

This is the first British book to be published on micro-electronics for the amateur experimenter. With circuit diagrams, layouts and easy instructions, it shows how to construct ten practical radio and electronic devices using integrated circuits (IC's) which are now available at low cost from many component stores. Micro-electronics—the big development in electronics since the transistor—involve complex circuits in the form of tiny "chips", incorporating several circuit elements, to which it is only necessary to make connections. Various kinds of micro-circuits are already available to amateurs, with new ones regularly coming on to the market. In this book the authors provide, in addition to practical projects, an introduction which shows clearly the present state of the art and a summary of the items available commercially. The advent of the integrated circuit (IC) opens up a fascinating new field for the electronics student, constructor and experimenter. This book shows how to get started and produce some really interesting and worthwhile equipment.

£1.01 post free

### HANDBOOK OF TRANSISTOR CIRCUITS

By Allan Lytel

Here is a collection of more than 200 practical transistorised circuits for use in counters, power controls, timers, indicators, photoelectric devices, power regulators, amplifiers, power supplies, oscillators, power converters and other applications. Schematic diagrams, parts lists and descriptions of operation are included for each circuit.

Planned as a supplement and companion volume to author Lytel's previous book, *Transistor Circuit Manual*, many of the circuits employ such specialised semi-conductor devices as silicon-controlled rectifiers, photocells, zener diodes, and tunnel diodes, in addition to standard diodes and transistors.

This book is a handy source of information on the design, operation, and application of a wide variety of transistorised circuits. Engineers, technicians, students, and hobbyists will all find the circuits of interest and the material of value in research, development, experiment, and general studies of circuitry.

£2.35 post free

### PRACTICAL WIRELESS CIRCUITS

There are more than 50 different circuits detailed in this book. Transistor receivers, 22 in all, range from an ultra-simple crystal diode circuit to a very sophisticated 10-transistor communications Rx. Valve receivers cover MW, SW and FM. Transistor and valve amplifiers include preamplifier, PA and Stereo.

There is a chapter on transmitters and transceivers, and another on transmitter and receiver circuits for Model Control. Circuits for a progressive range of test gear cover everything from a simple Transistor Tester to a Comprehensive Multimeter, including a Pocket Signal Tracer (RF, AF and IF), also FM, Square-Wave and Noise Generators.

Among the special circuits are a recording level meter for tape recorders, an electronic photographic timer and a solar cell receiver.

The first few simple circuits are accompanied by step-by-step instructions to enable the absolute beginner to gain enough experience with circuitry building to tackle the more complicated work.

£1.34 post free

### 49 EASY TRANSISTOR PROJECTS

This book is for the electronic hobbyist who is interested in developing projects that can be fun as well as useful. Most projects can be constructed in one evening using only a few inexpensive parts. Many of the parts can be salvaged from old radio and television chassis.

Each project is presented in an easy-to-understand way, with a parts list and a schematic diagram. Many value substitutions can be made in resistors and capacitors without affecting the end result, providing that the proper transistors, coils, and transformers are used.

Projects in this book, which include an AM radio, an FM receiver, light relay controls, audio amplifiers, code practice oscillators and test equipment—each designed with only two transistor types.

£1.01 post free

### 110 SEMICONDUCTOR PROJECTS

Due to the rapid advances in semiconductor technology, many engineers and certainly most amateurs have found it impossible to keep track of the new devices that become available because of lack of readable information. This book introduces the reader to such outstandingly useful new devices as the field-effect transistor, junction transistors, silicon controlled-rectifiers, silicon planar transistors and integrated circuits, giving their properties and methods of operation, with full constructional details of many exceptionally useful circuits.

Of particular interest to the amateur are simple amplifiers, lamp and relay driving circuits, electronic switches—operated by light, sound or contact with water—and delay circuits ranging from a fraction of a second to 35 minutes. Among the many circuits which will be of interest to the practising engineer are amplifiers with input impedance as high as 500 megohms, voltage and current regulators, waveform generators, analogue-to-digital converters and logic circuits. All circuits are designed around internationally available semiconductors.

124 pages, including 110 illustrations

£1.37 post free



**RADIO AND ELECTRONIC HANDBOOK**

by G. R. Wilding

Technicians and service engineers in the Radio and Electronics industry require a considerable amount of data which is spread over many books. It is often difficult and time consuming to locate in a hurry. Students, however, who may have to study a whole series of course-books will find a condensation of such information, which gets down to the essentials, extremely useful. *Radio & Electronic Handbook* has been designed to provide, on the one hand, a reference book and, on the other, a revision guide.

The intention has been to summarise basic electronics into four separate, easily assimilated sections, which will provide rapid reference to important principles, formulae and applications. These four main sections are: Direct current theory; Alternating current theory; Valve theory and applications; and Transistor theory and applications. Practical worked examples and circuit diagrams have also been utilised whenever necessary.

The concise presentation, which covers all the relevant ground, makes for easy learning and the book should prove invaluable for both practical and examination requirements, £1.28  
149 pages including 84 diagrams.

**QUESTIONS AND ANSWERS ON RADIO AND TV**

3rd Edition

## PREFACE

Curiosity is the keystone of learning. The man who "wants to know" has a far better chance of digesting and retaining information than he who ploughs through a set subject simply because it has been put before him.

Hence the "Question and Answer" form of this little book. Wherever possible, the questions have been arranged to follow the growth pattern of information. Questions arise from the previous answers. This means that the book differs from a standard textbook in that subjects are not cajoled neatly into place; except that main chapter headings give a guide to the line of questioning, the reader can treat these pages as bedside or benchside reading. Mathematics and unwieldy formulae have been avoided. Circuits and other diagrams give the basic information and confusing frills are omitted.

There are many textbooks to which the reader who wishes to augment the information given here can resort. These chapters will whet his curiosity

83p

**PRINCIPLES OF AERIAL DESIGN**

by H. Pope

The principles involved in the design of aeriels are by no means easy for the student to assimilate because they require a knowledge of field theory, which involves more difficult concepts than the more familiar circuit theory. In an endeavour to be precise and exhaustive it is all too easy to complicate the treatment, and so become involved in a welter of abstruse mathematics. On the other hand, if the subject is over-simplified the treatment can easily become purely descriptive, at the expense of an understanding of the principles involved.

In this book—which is not exclusively of amateur-band interest but more on Aerial Theory for the general reader—the author attempts to steer a middle course between these two extremes. The theory of aeriels is developed from first principles, but where approximations are necessary in order to avoid mathematical complication the reasons are given and the significance of the approximations indicated. By this means the reader is given a succinct introduction to the more important aspects of the theory of aeriels while the practical forms used in the frequency bands up to 30 MHz are also briefly described.

It opens with an exposition of the laws governing electric and magnetic phenomena upon the basis of field theory, and the fundamental concepts and quantities are introduced and defined. The theory and practical applications of Maxwell's electro-magnetic wave equations are next dealt with (and there is an appendix which gives the derivation of the vector formulae employed). The next chapter is concerned mainly with the two important characteristics of an aerial for transmission or reception—the radiation pattern and the impedance—while the final chapter describes the practical forms which aeriels take for particular uses and the various techniques employed to obtain the best effect.

The author has been employed for many years in the Research Department of the British Broadcasting Corporation; he also gives a post-graduate course of lectures on Aeriels and Propagation in the Electrical Engineering Department of Imperial College, London. His book is as much for the seriously interested amateur as for the professional. 172 pages, including 96 text diagrams, plus 6 pages of art plates.

£2.60

**DICTIONARY OF ELECTRONICS**

by Harley Carter, M.I.E.E.

The field of electronics has widened to such an extent that, with the new terms introduced in specific branches of the subject, the student and even the scientist find it difficult to keep up with new developments. Many engineers trained in alternative fields of technology are nowadays having to apply their knowledge to electronics. It is with these points in mind that this illustrated dictionary is presented.

Priority has been given to the inclusion of fundamental facts and terms, and the other entries to a large extent follow on from these. Also listed are familiar terms and descriptions of many electronic instruments. Much supplementary material is given as an Appendix, including circuit symbols, abbreviations, colour codes, conversion tables and valve bases.

The concise but explanatory definitions from many branches of electronics—including radio, television, communications, radar, electronic instrumentation and industrial electronics—should prove of use to engineers, students, technicians, apprentices and to all those whose work or interest requires them to understand modern electronic terminology. £1.88  
Second Edition

**INTEGRATED CIRCUIT POCKET BOOK**

by R. G. Hibberd

This book is a logical companion to the Authors' previous book—The Transistor Pocket Book, and is intended primarily for technicians and students whose courses include semi-conductors devices, but it will also be of interest to all those who are concerned with integrated circuits and their applications.

£2.60 (post free)

**DICTIONARY OF TELECOMMUNICATIONS**

R. A. Bones, B.Sc., Ph.D., ACIS, CEng., M.I.E.E., AInstP.

Economic growth throughout the world is closely linked with the development and growth of telecommunication systems. Modern industry demands ever-improving facilities for its executives to be able to speak to each other from opposite sides of the globe; to be able to transmit drawings, documents and pictures rapidly over large distances; and now to be able to send data accurately and quickly from computer to computer.

Telecommunications is an industry with a high growth rate and, like all technologically based industries, a new language has developed: a language which grows daily as new materials, techniques and systems are developing. This dictionary is an attempt to document that language.

The wide range of definitions, including many reproduced from, or based on, British Standards recommendations, is supplemented by appendices including units and abbreviations, wavelengths and frequency bands, and signal reporting codes.

The concise explanations of the terms in use should prove valuable to engineers, students, technicians, and to all whose work or interest requires them to understand modern telecommunication terminology. £2.35

**MICROPHONES**

by A. E. Robertson

A general treatment, in twelve chapters with appendices.

£1.40

**WIRE ANTENNAS FOR RADIO AMATEURS**

by W. I. Orr

What this Handbook contains:—How to build tested wire antennae (for two metres to 160m.—Top Band) that really get out—horizontals, verticals, beams, trap antennae, ground planes, etc.

"Invisible" aeriels for amateurs in flats and other locations where radio and TV antennae are "prohibited."

Exact dimensions in feet and inches—also in metres and centimetres—for every antenna described—no guesswork!

How to build two "all-purpose" aerial tuners with 100 uses!

The truth about baluns. How to build an efficient, inexpensive balun for optimum antenna performance and accurate SWR readings

The construction of 2, 3, 4 and 5-band trap dipoles. How to make your own efficient traps and save real money.

Three-band dipole for 80, 40 and 15 metres—only one feedline!

Ground plane aeriels for VHF and 10, 15, 20 and 40 metres.

High-gain beam antennae especially suited for VHF FM.

The efficient "folded Marconi" antenna for 40, 80 or 160 metres.

Clear explanations of resonance, radiation resistance, impedance, standing wave ratio (SWR), balanced and unbalanced aeriels.

Plus—radial wire ground systems; lightning protection; wood masts; counterweights; the easy way to use coax connectors—and much more!

This book is an American publication by a well-known author in the field of Amateur Radio. £1.72

**Available from**

Publication Dept., 55 Victoria St., London SW1H 0HF

01-222 5341

(Counter Service. 9.30-5.15. Mon. to Fri.)

(Nearest Station: St. James's Park)

(GIRO A/C. No. 547 6151)

**SHORT WAVE MAGAZINE**

A limited number of these titles specially imported from the States—please order your copy early. It may not be possible to repeat some of these.

#### ABC'S OF SHORT-WAVE LISTENING

Have you ever listened to a radio and thought how enjoyable it would be to hear broadcasts from faraway places, such as Toronto, Berlin, and Tokyo, as well as signals from ships at sea and satellites in space. All these broadcasts can be at your fingertips, offering a fascinating hobby.

*ABC's of Short-Wave Listening* a non-technical guide, will help you get started, or give you added pointers if you are now engaged in the hobby. The mysteries of radio waves are revealed in a manner that anyone can understand, providing priceless knowledge about the ever-expanding world of short-wave radio. £1-60

#### BUILDING YOUR AMATEUR RADIO NOVICE STATION

This book is the first "completely detailed" construction manual for building an amateur novice radio station. Nothing is overlooked in building the station from scratch to the actual on-the-air operation. The transmitter and receiver are distinctly professional in performance quality and appearance.

The book is primarily directed to the novice radio ham, it contains many novel and valuable construction hints and tips for amateurs in any licence class. As a finished touch to the projects a complete "rollaway" ham shack for hams with limited space (apartment dwellers, etc.) is featured and fully described. By W7OE £1-90

#### HAM ANTENNA CONSTRUCTION PROJECTS

Besides full details on many useful and interesting types of aeriels, Ham Antenna Construction Projects includes complete information on long-lasting construction methods, as well as how to position your antenna to achieve maximum distance with a given radiation pattern. In addition, much easy-to-understand technical information on tuning antennas and the use of test equipment is presented. £2-10

#### SWL ANTENNA CONSTRUCTION PROJECTS

Two chapters cover the basic principles of antennae and the knowledge necessary for construction of the projects which are given in the following pages. The antenna projects themselves are divided into six classes. First are the dipole aeriels such as segmented and inverted types. Following them are the vertical antennae, including array and beam types. Then horizontal beam systems (Yagis) are considered. Various low- and high-band and multiband triangle antennae are also discussed. The next section deals with long-wire antennae, such as vee beams and rhombics, for those SWL'ers with a sizeable plot of land available. For SWL'ers without land, indoor antennae, which are included in the final section, may be a solution. Three useful appendices are provided at the end of the book. £1-60

#### TRANSISTOR FUNDAMENTALS—Vol. III

Covers circuits used in radio, audio and television equipment. It also introduces you to logical troubleshooting procedures used in locating defective parts or faulty adjustments in these circuits. This book will help you learn to repair many transistor circuits used in audio amplifiers, radio and television receivers. £2-40

#### RADIO CIRCUITS

By Thomas M. Adams

This volume goes into great detail in explaining the action of the various circuits used in radio receivers—also voltage analysis and signal substitution methods for servicing typical valve and transistor receivers. £1-80

*The above prices include postage and packing*

Available from

## SHORT WAVE MAGAZINE

Publication Dept.,

55 Victoria St., London SW1H OHF

Telephone 01-222 5341

(Counter Service 9.30-5.15 Monday to Friday)

(Nearest Station: St. James's Park)

GIRO A/C. No. 547 6151)

## CALL BOOKS

### INTERNATIONAL :

<b>RADIO AMATEUR CALL BOOKS (1973)</b>	
"DX Listings" . . . . .	£2-95
"U.S. Listings" . . . . .	£3-75
"G's" only 1973 . . . . .	70p

## MAPS

### AMATEUR RADIO MAP OF WORLD

Mercator Projection — Much DX Information — in colour. Second Edition . . . . . 65p

### DX ZONE MAP (GREAT CIRCLE)

In colour with Country/Prefix Supplement Revised to January 1972 . . . . . 85p

### RADIO AMATEUR MAP OF THE U.S.A. AND NORTH AMERICA

State boundaries and prefixes, size 24" by 30", paper . . . . . 60p

### RADIO AMATEUR'S WORLD ATLAS

In booklet form, Mercator projection, for desk use. Gives Zones and Prefixes (New Edition). . . . £1-10

## LOG BOOKS

Standard Log (New Glossy Cover) . . . . .	55p
Receiving Station Log . . . . .	45p

*(The above prices include postage and packing).*

## MORSE COURSES

### G3HSC Rhythm Method of Morse Tuition

*Complete Course with three 3 speed L.P. records with books	£4-50
*Beginner's Course with two 3 speed L.P. records with book .	£3-30
Single 12" L.P. Beginner's with book . . . . .	£2-75
Single, 12" L.P. Advanced with book . . . . .	£2-75
Three speed simulated GPO test. 7" d.s.E.P. record . . . . .	85p

*Prices include postage, packing and insurance in U.K. only \*Overseas orders + £1-00.*

Available from

## SHORT WAVE MAGAZINE

Publications Dept., 55 Victoria Street, London, SW1H OHF . . . . . 01-222 5341

(Counter Service, 9.30-5.15, Mon. to Fri.)

(Nearest Station: St. James's Park)

(GIRO A/C No. 547 6151)

# Technical Books and Manuals

(ENGLISH AND AMERICAN)

## AERIAL INFORMATION

ABC of Antennas . . . . .	90p
Aerials (By D. Sjobbema) . . . . .	88p
Aerial Handbook (Briggs) . . . . .	87p
Amateur Radio Antennas (Hooton) . . . . .	£1-87
Antenna Handbook, Volume 1 . . . . .	£1-77
Antenna Round-Up, Volume 1 . . . . .	£1-47
Antenna Round-Up, Volume 2 . . . . .	£1-77
Antenna Handbook, 12th Edition (ARRL) . . . . .	£1-40
Beam Antenna Handbook, 4th Edition . . . . .	£2-10
Quad Antennae, 2nd Edition . . . . .	£1-80
Simple Low Cost Wire Antennas . . . . .	£1-72
S9 Signals . . . . .	O/P
73 Vertical, Beam and Triangle Antennas (by E. M. Noll) . . . . .	£2-40
73 Dipole and Long-Wire Antennas (by E. M. Noll) . . . . .	£2-20

## BOOKS FOR THE BEGINNER

Amateur Radio (Rayer) . . . . .	£1-60
Beginners Guide to Radio (7th Edition) . . . . .	£1-12
Beginners Guide to Electronics (N.E.) . . . . .	£1-10
Beginners Guide to Transistors . . . . .	£1-12
Beginners Guide to Colour TV . . . . .	82p
Better Short Wave Reception, 2nd Edition . . . . .	£1-80
Course in Radio Fundamentals (N.E.) . . . . .	£1-15
Foundations of Wireless and Electronics . . . . .	£2-02
Guide to Amateur Radio (N.E.) . . . . .	89p
Ham Radio (A beginner's Guide) by R. H. Warring . . . . .	£1-72
How to Become a Radio Amateur . . . . .	59p
Learning the RT Code . . . . .	27p
Morse Code for the Radio Amateur . . . . .	15p
Radio, by D. Gibson . . . . .	85p
Radio Amateur Examination Manual (N.E.) . . . . .	89p
Simple Short Wave Receivers (Data) . . . . .	89p
Understanding Amateur Radio . . . . .	£1-37

## GENERAL

ABC of Electronics (by Farl J. Waters) . . . . .	£1-20
ABC of FET's . . . . .	£1-35
ARRL Calculator, Type A . . . . .	92p
ARRL Calculator, Type B . . . . .	O/P
Easibinder (to hold 12 copies of Short Wave Magazine together) . . . . .	90p
FET Circuits (by Rufus P. Turner) . . . . .	£1-52
FET Principles, Experiments and Projects . . . . .	£2-15
Guide to Broadcasting Stations (16th Edition) . . . . .	60p
Having Fun with Transistors . . . . .	£1-59
How to Listen to the World—7th Edition . . . . .	£1-90
Know Your Oscilloscope (by Paul C. Smith) . . . . .	£1-80
Microphones . . . . .	£1-65
Practical Integrated Circuits (Newnes-Butterworth) . . . . .	£1-01
Practical Transistor Theory . . . . .	£1-10
Practical Wireless Circuits . . . . .	£1-34
Prefix List of Countries . . . . .	23p
Radio Engineers Pocket Book (Newnes) (N.E.) . . . . .	£1-26
RCA Designer's Handbook (Solid State Power Circuits) . . . . .	£3-50
RCA Receiving Tubes Manual . . . . .	£1-77
RCA Transistor Thyristor and Diode Manual . . . . .	£1-75
RCA Transmitting Tubes . . . . .	£1-35
Shop and Shack Shortcuts . . . . .	£1-75
Single Sideband: Theory & Practice (by H. D. Hooton) . . . . .	£3-47

O/P (out of print)

The above prices include postage and packing.

Many of these Titles are American in origin.

Telecommunications Pocket Book (T. L. Squires) . . . . .	£1-32
World Radio and TV Handbook 1973 Edition . . . . .	£3-00
110 Integrated Circuit Projects for the Home Constructor . . . . .	O/P
49 Easy Transistor Projects . . . . .	£1-01
110 Semi-Conductors Projects for the Home Constructor (Iliffe) . . . . .	£1-37

## HANDBOOKS AND MANUALS

Amateur Radio DX Handbook . . . . .	£2-17
Electronic Circuit Handbook, Vol. 1 . . . . .	£1-42
Electronic Circuit Handbook, Vol. 2 . . . . .	£1-42
Mobile Handbook, CQ . . . . .	O/P
Mobile Manual, ARRL . . . . .	O/P
New RTTY Handbook . . . . .	£1-80
Radio Amateur Handbook 1972 (ARRL) . . . . .	O/P
Radio Amateur Handbook 1972 (ARRL) (Hard Cover) . . . . .	O/P
Radio & Electronic Handbook . . . . .	£1-32
Radio Amateur Operators Handbook, 12th Edition . . . . .	53p
Radio Communication Handbook (RSGB) . . . . .	£4-10
Rtty A-Z (CQ Tech. Series) . . . . .	£2-25
Surplus Conversion Handbook . . . . .	£1-37
Television Interference Manual (G3JGO) . . . . .	90p
Transistor Substitution Handbook No. 10 . . . . .	£1-12

## USEFUL REFERENCE BOOKS

Amateur Radio SSB Guide . . . . .	£1-59
Amateur Radio Techniques—4th Edition . . . . .	£1-80
Amateur Radio Construction Projects . . . . .	O/P
Amateur Radio Circuit Book . . . . .	O/P
Care & Feeding of Power Grid Tubes (Elmac Division of Varian) . . . . .	£1-60
Engineers' Pocket Book—6th Edition . . . . .	£1-48
Guide to Amateur Radio . . . . .	50p
'G' Call Book 1973 . . . . .	70p
Hams' Interpreter . . . . .	63p
Hints and Kinks, Vol. 8 (ARRL) . . . . .	62p
Operating an Amateur Radio Stat. . . . .	O/P
Radio Amateur Examination Manual (N.E.) . . . . .	89p
Radio Data Reference Book (3rd Edition) . . . . .	£1-00
Radio, Valve and Transistor Data (Iliffe), 9th Edition . . . . .	89p
Service Valve and Semiconductors Equivalents . . . . .	35p
Single Sideband for the Radio Amateur (ARRL), 5th Edition . . . . .	£1-67
Single Sideband (Theory & Practice) by H. D. Hooton . . . . .	£3-47
Sun, Earth and Radio by J. A. Ratcliffe . . . . .	91p
Surplus Schematics (CQ) . . . . .	£1-22
Transistor Pocket Book . . . . .	£1-57

## TRANSISTOR MANUALS

ABC of Transistors . . . . .	£1-33
Having Fun with Transistors . . . . .	£1-59
Handbook of Transistor Circuits . . . . .	£2-35
Transistor Audio & Radio Circuits (Mullard) . . . . .	£1-96
Transistor Fundamentals: Basic Semi-Conductor and Circuit Principles, Vol. 1 . . . . .	£1-92
Transistor Fundamentals: Basic Transistor Circuits, Vol. 2 . . . . .	£1-92
Transistor Substitution Handbook, No. 12 . . . . .	£1-50

## VHF PUBLICATIONS

VHF Handbook, Wm. I. Orr . . . . .	£1-79
VHF Manual (ARRL) . . . . .	£1-37
VHF/UHF Manual (RSGB) (N.E.) . . . . .	£1-80

Available from

Publication Dept., 55 Victoria St., London SW1H 0HF

(Counter Service. 9.30-5.15. Mon. to Fri.)

SHORT WAVE MAGAZINE

01-222 5341

(Nearest Station: St. James's Park)

(GIRO A/C. No. 547 6151)

# P. & P. DEVELOPMENTS

**Havant 72657**  
Shop Hours

WE SPECIALISE IN VHF EQUIPMENT  
FOR THE PROFESSIONAL AND AMATEUR!

**Cosham 74695**  
Evenings, Weekends

**MURPHY 821.** High band AM TX/RX QQVO3-10 final and driver stages, easily converted to 2m. ... £9, carr. 75p

**MURPHY 820.** Mid-band dash version of the 821, good condition will convert to 2 or 4 with circuit ... £6, carr. 75p

**MURPHY 807.** High power AM mobiles for 2 or 4 less QQVO3-20A but otherwise complete ... £8, carr. £1

**MURPHY BASE STATIONS.** High power AM complete units inc. p.s.u. ... £25, carr. £2

**COSSOR CC15.** Lowband AM Mobiles QQVO3-20A final, complete with all leads, speaker, mic., etc. ... £16-50, carr. £1

**GEC LOW BAND BASE** can be modified to 12½ kHz £27-50, carr. £2

**PYE AM10B.** Highband 12½ kHz (new GPO spec.) complete with all accessories in good condition ... £60, carr. £1

**PYE R470.** UHF Rx. all solid state, mint condition, ideal for 70 cms. receiver ... £45, carr. £1

**PYE.** Highband AM monitor receiver, 4 channels, ideal for converting to a 2m. base Rx., very clean condition... £35, carr. 75p

**HEATHKIT SB300.** Amateur bands receiver, mint condition, fitted noise limiter and speaker ... £80, carr. £1-50

**B44 Mk. III.** Ideal for 4m. ... £8-50, carr. 75p

**PLESSEY PV215.** High quality 5SB/DSB/AM/15B driver units, output frequency 100 kHz. Can be operated independently on USB and LSB at same time. Output level via 0-6 dB atten. LC type filters, superb scal ovens. The units are completely transistorised and in mint condition. £30, carr. £1

**PLESSEY PVT223A.** This unit will accept the 100 kHz above and mix giving output on 3-1 MHz ... £20, carr. 50p

**RADIO ALARMS.** New Murphy radio alarm units, contains 12v. p.s.u. audio board multi-programme cam unit. Ideal for host of spares, or as radio alarm ... £1-25, carr. 75p

**PYE MARINE TX.** Runs 2 x 5B254M's in final AM/CW/MCW xtal control on 8 channels or VFO in 1-5-16 MHz continuous coverage. In good condition complete only ... £10, carr. £1-50

**PSU's** for above Tx less valves but with control unit, £4, buyer collects

**PYE BASE STATIONS.** High or Low band units complete except QQVO3-20A. Ideal for converting. Separate p.s.u. for Tx and Rx. £10, carr. £1-50

**HF VFO/PA.** Contains 2 x 4X150A's chimney and blower, good condition ... £12, carr. 75p

**VHF FIBREGLASS WHIP AERIALS.** Ideal for cutting to ½ wave on 2m. ... £1, carr. paid

**MULLARD.** Tubular ceramic trimmers 0-6pf 14p, 0-12pf, 19p ea.

**INVERTEK PSU's.** 24v. input 425v. and 125 watts output. New. £4-25, carr. 50p

**LOW VOLTAGE RELAYS.** 24v. octal fitting ... 50p ea. or 3 for £1-25, carr. 10p

**MIC INSERTS.** Dynamic and carbon. ... 50p each, carr. 10p  
Lustraphone dynamic ... £1 ea, carr. 15p

**STC 633.** High band AM 12½ kHz mobiles, good condition £65, carr. £1

**PYE VANGUARDS.** High Band aim, TX/RX complete, good condition ... £10-50, carriage £1.

G8DBX

19 LONE VALLEY, WIDLEY, COSHAM, PORTSMOUTH, HANTS.

*Subscription rate to  
Short Wave Magazine is  
£3.00 (First Class)      £2.75 (Second Class)  
for twelve issues.*

## CREATE YOUR OWN REFERENCE LIBRARY

The "EASIBINDER" is designed to bind 12 copies of the Magazine as you receive them month by month, eventually providing a handsomely bound volume for the bookshelf.

No need to wait until twelve copies are assembled. As each copy is received, it is quickly and simply inserted into the binder. Whether partially or completely filled, the binder is equally effective, giving the appearance of a book, with each page opening flat.

Strongly made with stiff covers and attractively bound in maroon Leathercloth and Milskin, the binders have only the title gold blocked on the spine.

Price 90p post free.

PUBLICATIONS DEPARTMENT  
SHORT WAVE MAGAZINE  
55 VICTORIA STREET  
LONDON, SW1H 0HF

